

Paksmith[®]
SURGICO
WE KNOW HOW TO MANUFACTURE



EQUESTRIAN PRODUCTS

A FAMILY OWNED MANUFACTURING COMPANY SINCE 1930

WWW.PAKSMITH.COM

ABOUT US!

Founded in 1930 by Mian Lal Din (Late) as an instrument workshop, PAKSMITH quickly progressed to become the first Pakistan's manufacturer of veterinary instruments. In 1970 2nd generation Mr. Saleem Akhtar joins company and devoted his struggle made success in 1979 begins to exports. In 1993 3rd generation Mr. Naveed Akhtar joins and still working as Director Sales.

The staff of PAKSMITH surmounted with a crown, serves as the company's trademark and has been a symbol of quality and reliability for over years.

PAKSMITH headquarter is in Sialkot, a location renowned throughout the world as a center for manufacturers of surgical instruments, soccer balls and leather motorbike apparels.

Where as in early years, PAKSMITH began by concentrating on manufacturing basic Veterinary Instruments, over the decades, the company steadily expanded its range of EQUESTRIAN Products, CARRIAGE Accessories, EQUESTRIAN LEATHER Articles and FARRIER Tools, systematic diversification enabled it to develop into an all-round supplier in the field of horses and other animals.

In a process of continuous cooperation with the leading buyers throughout the world, innovative operating techniques and for improved quality are being developed in the areas of horse equestrian, now we have nice quality, shortest delivery time and best prices.

From the outset, innovation was the driving force behind PAKSMITH's rapid development. Animal health care has always been our central concern.

Today's PAKSMITH products provide the basis for tomorrow's conventional techniques. PAKSMITH is committed to provide quality products, innovative and responsive to the needs of our customers. In this sense we have partnerships with leading world best companies. In the continuity of our values, we expand and strengthen our partnerships to meet the expectations of our customers.

PAKSMITH products are developed strictly by the close contact to our customers. Throughout the world, our products have proved themselves in day-to-day practice, not least from the point of view of quality and cost.

Standards (DIN, ISO) have been created to define and monitor quality targets. A company that continuously meets such standards over a period of many years, and also define even more exacting tolerances for their own requirements can justifiably claim to practice quality management. Since 1999, PAKSMITH has held certifications based ISO9001, ISO9002. However, PAKSMITH provides consistent quality assurance completely independently of the Industrial Estate, Sialkot. All company staff are involved in the process of meeting quality standards.

If you need any further information, free samples please feel free contact naveed@paksmith.com

YOUR ATTENTION IS EXPRESSLY DRAWN TO THE CONTENT OF THIS TERMS & CONDITIONS OF SALES

Revised September 16, 2014

1. The obligations and rights of the party identified by the "sold to" on the front side hereof ("Buyer") and Paksmith Surgico. ("Seller") shall be governed solely by these terms and conditions. The provisions of any purchase order or other writing, or course of dealing, usage of trade or other conduct, inconsistent herewith shall not constitute a part of this contract of sale. If any of the terms and conditions hereof is not acceptable to Buyer, Buyer shall notify Seller in writing within five (5) business days of Buyer's receipt of this contract of sale. This is intended by the parties to be a final expression of their agreement and is a complete and exclusive statement of the terms and conditions of such agreement and supersedes all prior and contemporaneous promises, covenants, agreements, understandings, negotiations and discussions between the parties, whether oral or written.

2. LIMITED WARRANTY. Subject to the qualifications stated below, Seller warrants the products identified on the front side hereof ("Products") will be free from defects in material and workmanship under normal use and service for a period of ninety (90) consecutive days from the date first placed in service, provided such first date of service is within two hundred seventy (270) consecutive days from the date of shipment by Seller. Seller and its representatives may, from time to time, offer recommendations and advice with respect to the use of the Products. Any such recommendations and advice are not warranties by Seller, and Buyer will act upon any such recommendations and advice at Buyer's sole risk. Seller's liability and Buyer's exclusive remedy for any claims arising out of the Products sold hereunder shall be limited to replacement or repair of nonconforming goods or payment in an amount not to exceed the purchase price therefor, at Seller's option. Seller's approval must be obtained before any warranty service is performed by Buyer or any third party.

Except for defects in workmanship as described in the preceding paragraph, the foregoing warranty does not apply to the extent a Product that has been manufactured by Seller (i) is based on a design specified by Buyer, (ii) utilizes materials provided by Buyer, and/or (iii) utilizes materials either specified by Buyer or required by Buyer to be purchased by Seller from a supplier specified by Buyer.

THE FOREGOING WARRANTY AND REMEDIES ARE EXCLUSIVE AND IN LIEU OF ALL OTHER WARRANTIES AND REMEDIES WHATSOEVER, INCLUDING, BUT NOT LIMITED TO, IMPLIED WARRANTIES OF MERCHANTABILITY FITNESS FOR A PARTICULAR PURPOSE AND/OR NON-INFRINGEMENT. UNDER NO CIRCUMSTANCES SHALL SELLER BE LIABLE FOR INCIDENTAL, SPECIAL, PUNITIVE, CONSEQUENTIAL OR SIMILAR DAMAGES OR EXPENSES OF ANY KIND, INCLUDING LOSS OF INCOME OR PROFITS OR GOODWILL, ARISING OUT OF OR IN CONNECTION WITH THIS CONTRACT OR WITH THE USE OR DELIVERY OF PRODUCTS FURNISHED HEREUNDER.

3. PRICES AND TERMS OF SALE. The prices and terms of sale stated herein are EXW Seller's Facility for sales requiring shipment of goods or FCA Seller's Facility (per Incoterms 2010) for sales requiring shipment of goods to a location outside of Pakistan, and are based on the quantities specified for delivery in a single lot unless otherwise indicated on Seller's Order Acknowledgment and/or invoice. Such prices are subject to increase by Seller (i) for any order changes made by Buyer and approved by Seller, and (ii) with respect to multiple orders pursuant to a single purchase order, for any order confirmed after a general price increase made by Seller.

FOR ORDERING. You can Email us. naveed@paksmith.net or for information on any product, info@paksmith.net

4. FORCE MAJEURE. Seller shall not be liable for any delay in performance or nonperformance on the part of Seller directly or indirectly caused by fire, explosion, accidents, flood, labor trouble or shortage, war, act or regulation of any government, inability to obtain suitable material, equipment, fuel, power or transportation, act of God or otherwise arising from contingencies, happenings or causes beyond the commercially reasonable control of Seller. Quantities so affected by any such circumstances may be reduced by Seller without liability, but this agreement shall otherwise remain unaffected.

5. PAYMENT. Payment terms are net fifteen (15) days after shipment unless otherwise stated on the front of Seller's Invoice. Outstanding balances not paid when due shall be subject to a late charge accruing from the date of Seller's Invoice at the rate of the lower of eighteen percent (20%) per annum or the maximum interest allowable under applicable state law on any late payments due hereunder. Failure to timely pay any Seller Invoice shall cause all subsequent Invoices to become immediately due and payable. Payment shall be made as agreed by Buyer and Seller.

6. TAXES AND FEES. Prices stated herein do not include any taxes, charges, assessments, or duties, and the amount of any thereof which Seller is required to pay or collect shall be invoiced to and payable by Buyer. Buyer shall also pay any collection fees and reasonable attorneys' fees incurred by Seller in collecting payment of the purchase price and any other amounts for which Buyer is liable under the terms and conditions hereof.

7. SHIPMENT; RISK OF LOSS; TITLE. Unless otherwise agreed to in writing by the parties, deliveries of the goods shall be EXW Seller's Facility for sales requiring shipment of goods or FCA Seller's Facility (per Incoterms 2010) for sales requiring shipment of goods to a location outside of Pakistan. Seller shall place the goods in the possession of a carrier and will make a contract for their transportation as may be reasonable, having regard for the nature of the goods and generally accepted commercial standards. The Buyer shall be responsible for all expenses incurred in delivering the goods unless otherwise indicated by the governing terms of sale. Risk of loss of the goods and responsibility to insure the goods shall pass to Buyer per the governing terms of sale. Title to goods shall transfer upon Seller's satisfaction of delivery per the governing terms of sale.

8. CANCELLATION, MODIFICATION, SUSPENSION. Cancellation, modification, suspension, or delay in shipment of Buyer's order shall not be accepted on terms which will not fully indemnify and reimburse Seller against losses, costs and expenses arising therefrom; such indemnity to include, without limitation, recovery of all direct costs incurred and a normal profit.

9. CREDIT APPROVAL. Shipments, deliveries and performances of work shall at all times be subject to the approval of Seller's credit department. Seller may at any time decline to make any shipment or delivery or perform any work except upon receipt of payment in advance or upon such other payment terms as are acceptable to Seller's credit department.

10. PROPRIETARY RIGHTS. Buyer acknowledges and agrees that it is not acquiring any right, title or license in or to Seller's intellectual property or other proprietary rights associated with any of the Products.

11. ASSIGNMENT; BINDING EFFECT. Buyer shall not assign its rights or obligations under this Agreement or any interest therein without Seller's prior written consent. Any assignment without such consent shall be void and have no force and effect. This Agreement shall be binding and inure to the benefit of the parties hereto, their successors and permitted assigns, and their legal representatives.

12. CONTROLLING LAW; JURISDICTION; LANGUAGE. This transaction shall be governed by, and this Agreement shall be construed and enforced in accordance with, the laws of Pakistan without regard to any principles of conflicts of laws. Any and all legal actions or proceedings shall be brought only in the courts of Pakistan.

13. COMPLIANCE WITH EXPORT REGULATIONS. Commodities or technology exported from Pakistan are in accordance with the Export Administration Regulations. Buyer understands and agrees that diversion of commodities or technology contrary to Pakistan law is prohibited.

14. MISCELLANEOUS. (i) No provision of this Agreement may be amended or waived except in a writing signed by Seller and Buyer; (ii) a waiver of a breach shall not operate or be construed as a waiver of any subsequent breach; (iii) Seller may set off any amount due from Buyer, whether or not under this Agreement, against any amount which may become due to Buyer, whether or not under this Agreement; (iv) if any provision, clause or part, or the application thereof is held invalid, the remainder of this Agreement or the application if such provision, clause or part under other circumstances shall not be affected thereby; and (v) this Agreement may only be amended in writing signed by both parties hereto.

CONTENTS

STIRRUPS	5 - 20
LOOSE RING BITS	21 - 32
DOUBLE RING BITS	33
ANTI REARING BITS	34
EGG BUTT BITS	35 - 40
DEE RING BITS	41 - 44
ICELANDIC RING BITS	45- 47
BAUCHER RING BITS	48 - 49
KIMBLE WICK BITS	50
DRIVING BITS	51 - 55
WEYMOUTH BITS	56 - 57
LIVERPOOL BITS	58 - 62
PELHAM BITS	63 - 67
MARATHONS	68
FULL CHEEK BITS	69 - 72
SHOW JUMPING BITS	73 - 76
PORTUGUESE / VAQUERO BITS	77 - 80
GAG BITS	81-85
HACKAMORES	86 - 87
WALKING HORSE BIT	88 - 89
WESTERN BITS	90 - 102
WESTERN SPURS	104 - 109
ENGLISH SPURS	110 - 111
VAQUERO SPURS	112 - 115
CAVESONS	116
CARRIAGE LAMPS	117- 122
HOOF KNIVES	123 - 131
HOOF KNIVES SETS	132
FARRIERS KITS	133
FOLDING SEAT STICKS	134
FARRIER TOOLS	135 - 136
HOOF TOOLS	139 - 143
HOOF TESTERS	144 - 145
GROOMING ITEMS	146 - 148
OTHER ITEMS	149- 152
SADDLERY HARDWARE	153 - 157
HORSE DENTAL	158 - 160
GLOVES	161 - 166
CHAPS	167 - 192
HORSE BOOTS / BANDAGE ROLL	193
SADDLE PADS	194



STIRRUPS

STIRRUPS



FILLIS IRON STIRRUP (Stainless Steel)
WHITE RUBBER PAD, (BLACK also available)

Article No.	Size mm	Inch	Qualities Available	Pad Color	Box Qty.
A01-56	90	3-1/2	56	72	30
	100	4	56	72	30
	110	4-1/4	56	72	24
	115	4-1/2	56	72	24
	120	4-3/4	56	61	24
	125	5	56	72	24
	135	5-1/4	56	72	24

REPLACEMENT RUBBER PAD

Article No.	Size (mm)	Color	Box Qty.
A01-71	100	Black	200
A01-72	110	White	200
	115		200
	120		200
	125		200



FILLIS IRON STIRRUP (Stainless Steel)
BLACK RUBBER PAD, (WHITE also available)

Article No.	Size mm	Inch	Qualities Available	Pad Color	Box Qty.
A01-61	90	3-1/2	56	71	30
	100	4	56	71	30
	110	4-1/4	56	71	24
	115	4-1/2	56	71	24
	120	4-3/4	56	61	24
	125	5	56	71	24
	135	5-1/4	56	71	24



FILLIS IRON STIRRUP (CS/Powder Coated)
Assorted Colors Available
WHITE RUBBER PAD, (BLACK also available)

Article No.	Size mm	Inch	Qualities Available	Pad Color	Box Qty.
A01-BK	90	3-1/2	62	Black	72
A01-RD	100	4	62	Red	72
A01-BL	110	4-1/4	62	Blue	72
A01-GL	115	4-1/2	62	Gold	72
	120	4-3/4	62		72
	125	5	62		72
	135	5-1/4	62		72



FILLIS IRON STIRRUP (CS/Chrome Plated)
BLACK RUBBER PAD, (WHITE also available)

Article No.	Size mm	Inch	Qualities Available	Pad Color	Box Qty.
A01-02	90	3-1/2	02	71	30
	100	4	02	71	30
	110	4-1/4	02	71	26
	115	4-1/2	02	71	26
	120	4-3/4	02	71	26
	125	5	02	71	24
	135	5-1/4	02	71	24



FILLIS STIRRUP (Aluminum/Powder Coated)
Assorted Colors Available
WHITE RUBBER PAD, (BLACK also available)

Article No.	Size mm	Inch	Qualities Available	Pad Color	Box Qty.
A01-BK	90	3-1/2	52	Black	72
A01-RD	100	4	52	Red	72
A01-BL	110	4-1/4	52	Blue	72
A01-GL	115	4-1/2	52	Gold	71
	120	4-3/4	52		72
	125	5	52		72
	135	5-1/4	52		72



BRAND LASER MARKING & NICE HANGING
POLY BAG PACKING ALSO AVAILABLE

Best products with best prices

STIRRUPS



FILLIS IRON STIRRUP (German Silver)
WHITE RUBBER PAD, (BLACK also available)

Article No.	Size mm	Inch	Qualities Available	Pad Color	Box Qty.
A01-43	115	4-1/2	43	72	24
	120	4-3/4	43	72	24



OVAL STIRRUP (Stainless Steel)
BLACK RUBBER PAD, (White also available)

Article No.	Size mm	Inch	Qualities Available	Pad Color	Box Qty.
A13	120	4-3/4	56	61	71
	125	5	56	71	24



MOUNTING STIRRUP WITH STEP BAR (Stainless Steel)
BLACK RUBBER PAD, (WHITE also available)

Article No.	Size mm	Inch	Qualities Available	Pad Color	Box Qty.
A38	115	4-1/2	56	71	40
	120	4-3/4	56	71	40
	125	5	56	71	40

SOLD IN SINGLE, NOT PAIR



KIDS FILLIS STIRRUP (CS/Powder Coated)
BLACK RUBBER PAD, (WHITE also available)

Article No.	Size mm	Inch	Qualities Available	Pad Color	Box Qty.
A01-SB	90	3-1/2	62	Sky Blue	71
A01-OR	100	4	62	Orange	71
A01-PK	110	4-1/4	62	Pink	71
A01-GR	115	4-1/2	62	Green	71
A01-RD	120	4-3/4	62	Red	71
A01-PR	125	5	62	Purple	71



FILLIS STIRRUP (Stainless Steel Magnetic)
BLACK RUBBER PAD, (WHITE also available)

Article No.	Size mm	Inch	Qualities Available	Pad Color	Box Qty.
A39-57	90	3-1/2	57	71	30
	100	4	57	71	30
	110	4-1/4	57	71	26
	115	4-1/2	57	71	26
	120	4-3/4	57	71	26
	125	5	57	71	24



STIRRUPS



FILLIS STIRRUP (Aluminum Transparent Color)
BLACK RUBBER PAD, (WHITE also available)

Article No.	Size mm	Inch	Qualities Available	Pad Color	Box Qty.
A01-BL	90	3-1/2	63	Blue	71 40
A01-RD	100	4	63	Red	71 40
A01-RT	110	4-1/4	63	Rust	71 40
	115	4-1/2	63		71 40
	120	4-3/4	63		71 40



OFFSET STIRRUP (Stainless Steel)
WHITE RUBBER PAD, (BLACK also available)

Article No.	Size mm	Inch	Qualities Available	Pad Color	Box Qty.
A10	120	4-3/4	56	61	71 24
			43	German Silver	24
			33	Solid Brass	24

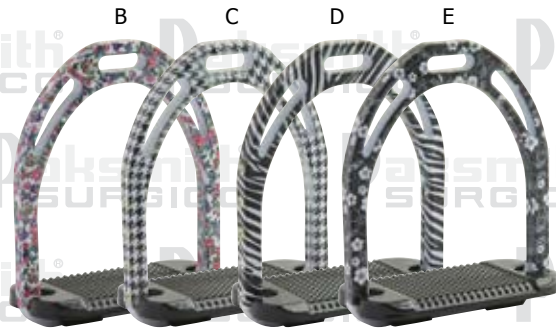

JIN STIRRUP (Aluminum/Powder Paper Coated) Assorted Designs Available

Article No.	Size mm	Inch	Qualities Available	Box Qty.
A51-A	120	4-3/4	47	30
A51-B	120	4-3/4	47	30
A51-C	120	4-3/4	47	30
A51-D	120	4-3/4	47	30
A51-E	120	4-3/4	47	30



JIN STIRRUP (Aluminum/Colored) Assorted Colors Available

Article No.	Size mm	Inch	Qualities Available	Color	Box Qty.
A50-A	120	4-3/4	48	Red	30



JIN STIRRUP (Aluminum/Powder Coated) Assorted Colors Available & Anodized Colors

Article No.	Size mm	Inch	Qualities Available	Color	Box Qty.
A40-BK	120	4-3/4	52	46	Black 30
A40-RD	120	4-3/4	52	Red	30



Best products with best prices

STIRRUPS



ENGLISH HUNT STIRRUP (German Silver)
WHITE RUBBER PAD, (BLACK also available)

Article No.	Size mm	Inch	Qualities Available	Pad Color	Box Qty.
A12	115	4-1/2	43	33	72 24
	120	4-3/4	56	02	72 24



OFFSET STIRRUP (Stainless Steel)
BLACK RUBBER PAD, (WHITE also available)

Article No.	Size mm	Inch	Qualities Available	Pad Color	Box Qty.
A34	120	4-3/4	56	61	71 24
				40	71 24



FILLIS STIRRUP 8mm BASE (Aluminum)
BLACK RUBBER PAD, (WHITE also available)

Article No.	Size mm	Inch	Qualities Available	Pad Color	Box Qty.
A06	120	4-3/4	51	71	40



FILLIS STIRRUP (CS/Powder Paper Coated) BLACK RUBBER PAD, Assorted Designs Available.

Article No.	Size mm	Inch	Pad Color	Box Qty.
A54-A	90	3-1/2	71	30
A54-B	100	4	71	30
A54-C	110	4-1/4	71	24
A54-D	115	4-1/2	71	24
A54-E	120	4-3/4	71	24
A54-F				
A54-G				

STIRRUPS



▶ PORTUGUESE ARGOLA STIRRUP (Brass/Chrome Plated)

Article No.	Size mm	Inch	Qualities Available	Box Qty.
A23-35	115	4-1/2	35	28



▶ PORTUGUESE ARGOLA STIRRUP (Solid Brass)

Article No.	Size mm	Inch	Qualities Available	Box Qty.
A23	115	4-1/2	33	28



▶ PORTUGUESE ARGOLA STIRRUP (Brass/Chrome Plated)

Article No.	Size mm	Inch	Qualities Available	Box Qty.
A27-35	115	4-1/2	35	28



▶ PORTUGUESE ARGOLA STIRRUP (Solid Brass)

Article No.	Size mm	Inch	Qualities Available	Box Qty.
A27	115	4-1/2	33	28



▶ CLASSIC STIRRUP (Stainless Steel) Also available in Brass

Article No.	Size mm	Inch	Qualities Available	Box Qty.
A29	115	4-1/2	56	24
	115	4-1/2	33	24

Exclusively Designed

Best products with best prices

STIRRUPS



▶ ICELANDIC STIRRUP (Stainless Steel) BLACK RUBBER PAD, (WHITE also available)

Article No.	Size mm	Inch	Qualities Available	Pad Color	Box Qty.
A07-56	120	4-3/4	56	71	20
			33	Solid Brass	20

REPLACEMENT RUBBER PAD

Article No.	Size (mm)	Color	Box Qty.
A07-71	115	Black	200
A07-72	120	White	200



▶ ICELANDIC STIRRUP (Aluminum Powder Coated) Assorted Colors Available BLACK RUBBER PAD, (WHITE also available)

Article No.	Size mm	Inch	Qualities Available	Pad Color	Box Qty.
A07-RD	120	4-3/4	52	Red	71
			51	Aluminum	40



▶ ICELANDIC STIRRUP (Aluminum Powder Coated) Assorted Colors Available BLACK RUBBER PAD, (WHITE also available)

Article No.	Size mm	Inch	Qualities Available	Pad Color	Box Qty.
A07-SL	120	4-3/4	52	Silver	71
A07-BK			52	Black	71
A07-GL			52	Gold	71



▶ ICELANDIC STIRRUP (Aluminum Transparent Color) Assorted Colors Available BLACK RUBBER PAD, (WHITE also available)

Article No.	Size mm	Inch	Qualities Available	Pad Color	Box Qty.
A07-RT63	120	4-3/4	63	Rust	71
A07-RD63			63	Red	71



▶ ICELANDIC STIRRUP (Aluminum Transparent Color) Assorted Colors Available BLACK RUBBER PAD, (WHITE also available)

Article No.	Size mm	Inch	Qualities Available	Pad Color	Box Qty.
A07-BL63	120	4-3/4	63	Blue	71

STIRRUPS



▶ ICELANDIC STIRRUP WIRE MADE (Stainless Steel)
BLACK RUBBER PAD, (WHITE also available)

Article No.	Size mm	Inch	Qualities Available	Pad Color	Box Qty.
A30	115	4-1/2	56	72	30



▶ ICELANDIC STIRRUP WIRE MADE (Solid Brass)
BLACK RUBBER PAD, (WHITE also available)

Article No.	Size mm	Inch	Qualities Available	Pad Color	Box Qty.
A30-33	115	4-1/2	33	72	30



▶ ICELANDIC STIRRUP (Stainless Steel)
BLACK RUBBER PAD, (WHITE also available)

Article No.	Size mm	Inch	Qualities Available	Pad Color	Box Qty.
A09	120	4-3/4	56	71	20



▶ SAFETY STIRRUP (Stainless Steel)
BLACK RUBBER PAD, (WHITE also available)

Article No.	Size mm	Inch	Qualities Available	Pad Color	Box Qty.
A05	110	4-1/4	56	71	20
	120	4-3/4	56	71	20



▶ SAFETY STIRRUP (Stainless Steel)
WHITE RUBBER PAD, (BLACK also available)

Article No.	Size mm	Inch	Qualities Available	Pad Color	Box Qty.
A22	120	4-3/4	56	72	20

Best products with best prices

STIRRUPS



▶ SAFETY STIRRUP SIDE STRAP (Stainless Steel)
BLACK RUBBER PAD, (WHITE also available)

Article No.	Size mm	Inch	Qualities Available	Pad Color	Box Qty.
A35	120	4-3/4	56	Black 71	20



▶ STIRRUP SIDE STRAP (Stainless Steel)
BLACK RUBBER PAD, (WHITE also available)

Article No.	Size mm	Inch	Qualities Available	Pad Color	Box Qty.
A36	120	4-3/4	56	71	22



▶ SAFETY STIRRUP 3 LINKS (Stainless Steel)
BLACK RUBBER PAD, (WHITE also available)

Article No.	Size mm	Inch	Qualities Available	Pad Color	Box Qty.
A37	120	4-3/4	56	Black 71	22



▶ SAFETY STIRRUP (Stainless Steel)
BLACK RUBBER PAD, (WHITE also available)

Article No.	Size mm	Inch	Qualities Available	Pad Color	Box Qty.
A02-56WH	120	4-3/4	56	White 71	22
A02-56BK	125	5	56	Black 71	22



▶ SAFETY STIRRUP (Stainless Steel)
BLACK RUBBER PAD, (WHITE also available)

Article No.	Size mm	Inch	Qualities Available	Pad Color	Box Qty.
A02-56GY	120	4-3/4	56	Grey 71	22
A02-56BL	125	5	56	Blue 71	22



STIRRUPS



SAFETY STIRRUP (CS/Powder Coated)
Assorted Colors Available
WHITE RUBBER PAD, (BLACK also available)

Article No.	Size mm	Inch	Qualities Available	Pad Color	Box Qty.
A46-BK	120	4-3/4	62	White	72
	125	5	62	Black	71
			62	Blue	76
			62	Red	77



SAFETY STIRRUP (CS/Powder Coated)
Assorted Colors Available
RED RUBBER PAD, (BLACK also available)

Article No.	Size mm	Inch	Qualities Available	Pad Color	Box Qty.
A46-RD	120	4-3/4	62	Red	77
	125	5	62	Blue	76
			62	White	72
			62	Black	71



SAFETY STIRRUP (CS/Powder Coated)
Assorted Colors Available
BLACK RUBBER PAD, (RED also available)

Article No.	Size mm	Inch	Qualities Available	Pad Color	Box Qty.
A46-BL	120	4-3/4	62	Black	71
	125		62	Blue	76
			62	White	72
			62	Red	77

Best products with best prices

STIRRUPS



SAFETY PEACOCK STIRRUP (Stainless Steel)
WHITE RUBBER PAD, (BLACK also available)

Article No.	Size mm	Inch	Qualities Available	Pad Color	Box Qty.
A04	95	3-3/4	56	72	30
	100	4	56	72	30
	110	4-1/4	56	72	24
	115	4-1/2	56	02	72
	120	4-3/4	56	61	72

REPLACEMENT RUBBER PAD

Article No.	Size (mm)	Color
A04-71	115	Black
A04-72	120	White

REPLACEMENT LEATHER PART

Article No.	Color
A04-LPBK	Black
A04-LPBR	Brown



SAFETY PEACOCK STIRRUP (CS/Powder Coated)
Assorted Colors Available
BLACK RUBBER PAD, (WHITE also available)

Article No.	Size mm	Inch	Qualities Available	Pad Color	Box Qty.
A47-RD	115	4-1/2	62	Black	71
	120	4-3/4	62	White	72
				Blue	76
				Red	77

REPLACEMENT RUBBER PAD

Article No.	Size (mm)	Color
A44-71	115	Black
A44-72	120	White
A44-76		Blue
A44-77		Red



SAFETY PEACOCK STIRRUP (Stainless Steel)
BLACK RUBBER PAD, (WHITE also available)

Article No.	Size mm	Inch	Qualities Available	Pad Color	Box Qty.
A44	100	4	56	72	30
	110	4-1/4	56	72	24
	115	4-1/2	56	72	24
	120	4-3/4	56	61	72

REPLACEMENT O-RUBBER RING

Article No.	Color
A04-RUB	Black



STIRRUPS



▶ VAQUERO STIRRUP LEATHER COVERED (CS/Power Coated)

Article No.	Size (cm)	Box Qty.
A26	10 x 15	10
	14 x 23	6
	14 x 26	6



▶ CAMARGUESE STYLE STIRRUP (CS/Power Coated)

Article No.	Size mm	Inch	Qualities Available	Box Qty.
A32	105	4	62 Black	24



▶ VAQUERA SCHOOL STIRRUP (CS/Power Coated)

Article No.	Size mm	Inch	Qualities Available	Box Qty.
A42	115	4-1/2	62 Black	20



▶ SAFETY STIRRUP W/PLASTIC CAGE, RUBBER PADS (Aluminum/Power Coated)

Article No.	Size mm	Inch	Qualities Available	Box Qty.
A28	115	4-1/2	52 Black	24
			51 Aluminum	24



▶ STIRRUP SIDE WAY STRAP (Aluminum)

Article No.	Size mm	Inch	Qualities Available	Box Qty.
A45	120	4-3/4	51	40

Available in Assorted colors

Best products with best prices

STIRRUPS



▶ POLO FOUR BARS STIRRUP (Stainless Steel)

Article No.	Size mm	Inch	Qualities Available	Box Qty.
A25-56	120	4-3/4	56	20

Available in Brushed Finish 20



▶ POLO FOUR BARS STIRRUP (Solid Brass)

Article No.	Size mm	Inch	Qualities Available	Box Qty.
A25-33	120	4-3/4	33	20



▶ ECONOMIC STIRRUP (CS/Chrome Plated)

Article No.	Size mm	Inch	Qualities Available	Box Qty.
A53	120	4-3/4	02	32
	130	5-1/8	02	32



▶ ENGLISH HUNT STIRRUP WITH NOTCHES (Stainless Steel) (Rubber Pads also available)

Article No.	Size mm	Inch	Qualities Available	Box Qty.
A11	115	4-1/2	56	24
	120	4-3/4	56	24



▶ ECONOMIC STIRRUP STRAIGHT LINE (CS/Chrome Plated)

Article No.	Size mm	Inch	Qualities Available	Box Qty.
A43	100	4	02	70

▶ ECONOMIC STIRRUP WITH NOTCHES (CS/Chrome Plated)

Article No.	Size mm	Inch	Qualities Available	Box Qty.
A33	100	4	02	70



STIRRUPS



▶ RACE STIRRUP (Stainless Steel)

Article No.	Size mm	Inch	Qualities Available	Box Qty.
A24	115	4-1/2	56	52



◀ RACE STIRRUP (Aluminum)

Article No.	Size mm	Inch	Qualities Available	Box Qty.
A41	90	3-1/2	51	72



▶ ECONOMIC STIRRUP (Plastic)

Article No.	Size mm	Inch	Colors Available	Box Qty.
A56	120	4-3/4	Black	72



▶ ECONOMIC STIRRUP BLACK RUBBER PAD (Plastic)

Article No.	Size mm	Inch	Colors Available	Pad Color	Box Qty.
A55	120	4-3/4	Black	Black	72



▶ OFF SET WESTERN STIRRUP 3" TREAD (Aluminum)

Article No.	Size mm	Inch	Qualities Available	Box Qty.
A31	75	3	49	14



▶ ECONOMIC STIRRUP KIDS (Plastic)

Article No.	Size mm	Inch	Colors Available	Pad Color	Box Qty.
A57-RD	115	4-1/2	Red	Black	72
A57-BK			Black	Blue	72
				Green	72
				Yellow	72
				Red	72



Best products with best prices

STIRRUPS



▶ WESTERN STIRRUP 2-1/2" TREAD (Aluminum Sheet Made) BLACK RUBBER PAD

Article No.	Neck Size (mm)	(Inch)	Qualities Available	Pad Color	Box Qty.
A08	55	2-1/4	51	71	32
A08-BR	70	2-3/4	51	49	71
A08-BK	75	3	51	71	32

Available in casted material economic price
Available without leather & rubber pads.



▶ WESTERN STIRRUP 2-1/2" TREAD (Aluminum)

Article No.	Neck Size (mm)	(Inch)	Qualities Available	Color	Box Qty.
A58	75	3	51	Brown	24



▶ WESTERN STIRRUP (Aluminum Sheet Made) BLACK RUBBER PAD

Article No.	Neck Size (mm)	(Inch)	Qualities Available	Color	Box Qty.
A59	45	1-3/4	51	Black	24
	55	2-1/4	51	Pink	24
	70	2-3/4	51	Red	24



▶ WESTERN STIRRUP WITH CAGE TREAD (Aluminum Sheet Made) BLACK RUBBER PAD

Article No.	Neck Size (mm)	(Inch)	Qualities Available	Color	Box Qty.
A52-RD	45	1-3/4	51	49	Black
	55	2-1/4	51	Red	20
	70	2-3/4	51	Blue	20



A14

A14-A

A14-B

▶ HAND ENGRAVED WESTERN STIRRUP 2-1/2" TREAD (Aluminum Sheet Made)

Article No.	Neck Size (mm)	(Inch)	Qualities Available	Pad Color	Box Qty.
A14-A	40	1-1/2	49	71	24
A14-B	55	2-1/4	49	71	24
A14-C	65	2-1/2	49	51	71
A14	75	3	49	71	24

Available with leather & rubber pads cost separately

STIRRUPS



WESTERN STIRRUP BLACK COVERED LEATHER (Made of Wood)

Article No.	Size (Inch) Tread Neck	Box Qty.
A48-65	2 2-1/2	34



WESTERN STIRRUP WITH BRASS SHEET (Made of Wood)

Article No.	Size (Inch) Tread Neck	Box Qty.
A17-75	2 3	34



WESTERN STIRRUP WITH SHEET (Made of Wood)

Article No.	Size (Inch) Tread Neck	Box Qty.
A20-75	2 3	34
A49-75	3 3	30



WESTERN STIRRUP WITH SHEET (Made of Wood)

Article No.	Size (Inch) Tread Neck	Box Qty.
A15-75	3 3	30



WESTERN STIRRUP WITH SHEET (Made of Wood)

Article No.	Size (Inch) Tread Neck	Box Qty.
A19-75	2 3	30



METAL BOUND ROPER STIRRUP WITH SHEET (Made of Wood)

Article No.	Size (Inch) Tread Neck	Box Qty.
A21-75	3 3	30



WESTERN STIRRUP WITH SHEET (Made of Wood)

Article No.	Size (Inch) Tread Neck	Box Qty.
A18-33.60	1-1/2 2-1/4	34



WESTERN ROUND STIRRUP WITH SHEET (Made of Wood)

Article No.	Size (Inch) Tread Neck	Box Qty.
A16-75	1 3	34

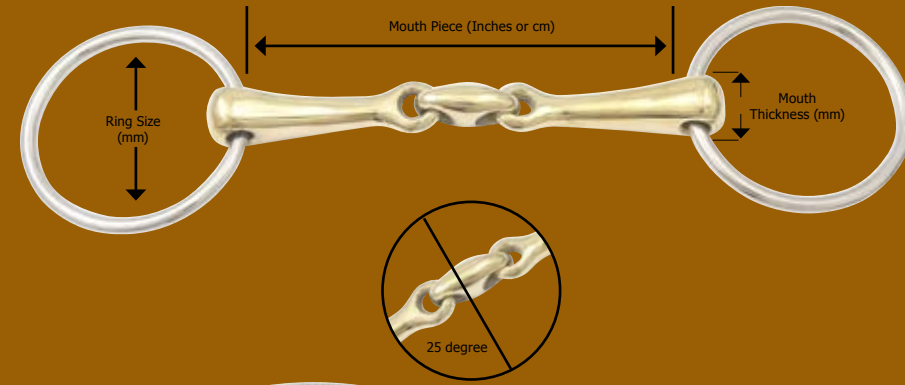

MOUTH PIECE
Stainless Steel, German Silver, Copper, Brass, Sweet Iron with Copper In-lays

RINGS
Available in Stainless Steel, Brass, German Silver, CS/Nickel Plated

SIZES
Inches: 4", 4-1/4", 4-3/4", 5", 5-1/4", 5-1/2", 5-3/4", 6", 6-1/4", 6-1/2", 6-3/4", 7"
Centimeters: 9.50cm, 10.50cm, 11.50cm, 12.50cm, 13.50cm, 14.50cm, 15.50cm

LOOSE RINGS

LOOSE RING BITS



LOOSE RING BIT DOUBLE BROKEN COPPER NUT MOUTH (STAINLESS STEEL)

Article No.	Size (mm)	Size (Inch)	Thickness (mm)	Ring-ø (mm)	Box Qty.	
D37-29	105	4	16	18	55	80
	115	4-1/2	16	18	65	80
	125	5	16	18	65	80
	135	5-1/4	16	18	65	80
D37-7.29	145	5-1/2	16	18	3"	80

LOOSE RING BIT DOUBLE BROKEN NUT MOUTH (GERMAN SILVER)

Article No.	Size (mm)	Size (Inch)	Thickness (mm)	Ring-ø (mm)	Box Qty.	
D37-43	115	4-1/2	16	18	55	80
	125	5	16	18	65	80
	135	5-1/4	16	18	65	80



LOOSE RING BIT DOUBLE BROKEN GERMAN SILVER MOUTH (STAINLESS STEEL)

Article No.	Size (mm)	Size (Inch)	Thickness (mm)	Ring-ø (mm)	Box Qty.
D110-88	115	4-1/2	16	55	80
	125	5	16	65	80
	135	5-1/4	16	65	80



LOOSE RING BIT DOUBLE BROKEN GERMAN SILVER MOUTH (STAINLESS STEEL)

Article No.	Size (mm)	Size (Inch)	Thickness (mm)	Ring-ø (mm)	Box Qty.		
D82-88	115	4-1/2	14	16	18	55	80
	125	5	14	16	18	65	80
	135	5-1/4	14	16	18	65	80



LOOSE RING BIT DOG BONE LINK MOUTH (STAINLESS STEEL)

Article No.	Size (mm)	Size (Inch)	Thickness (mm)	Ring-ø (mm)	Box Qty.
D16	115	4-1/2	16	55	80
	125	5	16	65	80
	135	5-1/4	16	65	80



LOOSE RING BIT DOG BONE LINK MOUTH (STAINLESS STEEL)

Article No.	Size (mm)	Size (Inch)	Thickness (mm)	Ring-ø (mm)	Box Qty.
D11	115	4-1/2	16	55	80
	125	5	16	65	80
	135	5-1/4	16	65	80
	145	5-1/2	16	65	80
D11-7	125	5	18	70	80

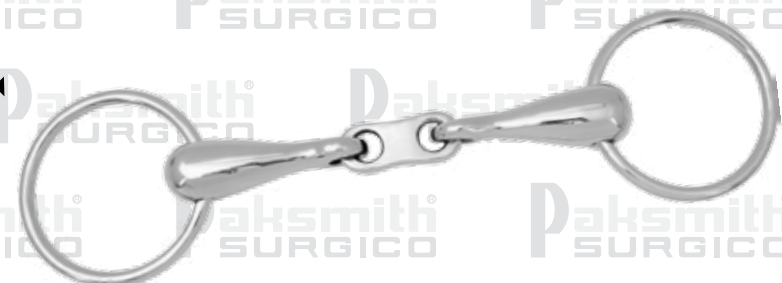

You never got so much for so little

LOOSE RING BITS



LOOSE RING BIT DOUBLE BROKEN MOUTH (STAINLESS STEEL)

Article No.	Size (mm)	Size (Inch)	Thickness (mm)	Ring-ø (mm)	Box Qty.
D83	115	4-1/2	18	55	80
	125	5	18	65	80
	135	5-1/4	18	65	80

LOOSE SS RING BIT DOUBLE BROKEN NUT MOUTH (GERMAN SILVER)

Article No.	Size (mm)	Size (Inch)	Thickness (mm)	Ring-ø (mm)	Box Qty.	
D37-88	115	4-1/2	16	18	55	80
	125	5	16	18	65	80
	135	5-1/4	16	18	65	80



LOOSE RING BIT DOUBLE BROKEN COPPER NUT MOUTH (STAINLESS STEEL)

Article No.	Size (mm)	Size (Inch)	Thickness (mm)	Ring-ø (mm)	Box Qty.
D85-29	115	4-1/2	16	55	80
	125	5	16	65	80
	135	5-1/4	16	65	80



LOOSE RING BIT DOUBLE BROKEN GERMAN SILVER MOUTH (STAINLESS STEEL)

Article No.	Size (mm)	Size (Inch)	Thickness (mm)	Ring-ø (mm)	Box Qty.	
D84-88	115	4-1/2	16	18	55	80
D84-29	125	5	16	18	65	80
	135	5-1/4	16	18	65	80



LOOSE RING BIT DOUBLE JOINTED COPPER ROLLER MOUTH (STAINLESS STEEL)

Article No.	Size (mm)	Size (Inch)	Thickness (mm)	Ring-ø (mm)	Box Qty.
D39-29	115	4-1/2	16	55	80
	125	5	16	65	80
	135	5-1/4	16	65	80



LOOSE RING BIT DOUBLE BROKEN COPPER MIDDLE NUT MOUTH (STAINLESS STEEL)

Article No.	Size (mm)	Size (Inch)	Thickness (mm)	Ring-ø (mm)	Box Qty.
D40-29	115	4-1/2	12	55	80
	125	5	12	65	80
	135	5-1/4	12	65	80



www.paksmith.com

www.paksmith.com

LOOSE RING BITS



LOOSE RING BIT SWEET IRON DOUBLE BROKEN COPPER ROLLER MOUTH (STAINLESS STEEL)

Article No.	Size (mm)	Size (Inch)	Thickness (mm)	Ring-ø (mm)	Box Qty.
D52-86	115	4-1/2	12	55	100
	125	5	12	65	100
	135	5-1/4	12	65	100

LOOSE RING BIT FLAT CURVE COPPER LINK SWEET IRON MOUTH (STAINLESS STEEL)

Article No.	Size (mm)	Size (Inch)	Thickness (mm)	Ring-ø (mm)	Box Qty.
D72-86	115	4-1/2	12	55	100
	125	5	12	65	100
	135	5-1/4	12	65	100



LOOSE RING BIT SWEET IRON DOUBLE BROKEN COPPER LINK MOUTH (STAINLESS STEEL)

Article No.	Size (mm)	Size (Inch)	Thickness (mm)	Ring-ø (mm)	Box Qty.
D47-86	115	4-1/2	12	55	100
	125	5	12	65	100
	135	5-1/4	12	65	100

D47-28 With Brass Rings

LOOSE RING BIT SWEET IRON 3 PCS COPPER RINGS MOUTH (STAINLESS STEEL)

Article No.	Size (mm)	Size (Inch)	Thickness (mm)	Ring-ø (mm)	Box Qty.
D107-86	115	4-1/2	12	55	100
	125	5	12	65	100
	135	5-1/4	12	65	100



LOOSE RING BIT DOUBLE BROKEN SS LINK HOLLOW MOUTH (STAINLESS STEEL)

Article No.	Size (mm)	Size (Inch)	Thickness (mm)	Ring-ø (mm)	Box Qty.
D61-56	115	4-1/2	17	55	120
	125	5	19	65	120
	135	5-1/4	19	65	120
	145	5-1/2	19	65	120

LOOSE RING BIT DOUBLE BROKEN SS LINK MOUTH (STAINLESS STEEL)

Article No.	Size (mm)	Size (Inch)	Thickness (mm)	Ring-ø (mm)	Box Qty.
D88-56	115	4-1/2	16	55	80
	125	5	16	65	80
	135	5-1/4	16	65	80
	145	5-1/2	16	65	80



You never got so much for so little

LOOSE RING BITS



LOOSE RING BIT SNAFFLE COPPER ROLLERS MOUTH (STAINLESS STEEL)

Article No.	Size (mm)	Size (Inch)	Thickness (mm)	Ring-ø (mm)	Box Qty.
D90-29	115	4-1/2	14	65	80
	125	5	14	65	80
	135	5-1/4	14	65	80

LOOSE RING BIT DOUBLE BROKEN COPPER ROLLER MOUTH (STAINLESS STEEL)

Article No.	Size (mm)	Size (Inch)	Thickness (mm)	Ring-ø (mm)	Box Qty.
D91-29	115	4-1/2	14	65	80
	125	5	14	65	80
	135	5-1/4	14	65	80



LOOSE RING BIT DOUBLE BROKEN COPPER NUT TWISTED MOUTH (STAINLESS STEEL)

Article No.	Size (mm)	Size (Inch)	Thickness (mm)	Ring-ø (mm)	Box Qty.
D92-29	115	4-1/2	14	65	80
	125	5	14	65	80
	135	5-1/4	14	65	80

LOOSE RING BIT BROKEN LINK WITH COPPER RING GERMAN SILVER MOUTH (STAINLESS STEEL)

Article No.	Size (mm)	Size (Inch)	Thickness (mm)	Ring-ø (mm)	Box Qty.
D93-88	115	4-1/2	14	55	80
	125	5	14	65	80
	135	5-1/4	14	65	80



LOOSE RING BIT DOUBLE BROKEN SS LINK MOUTH (STAINLESS STEEL)

Article No.	Size (mm)	Size (Inch)	Thickness (mm)	Ring-ø (mm)	Box Qty.
D74-56	115	4-1/2	16	55	80
	125	5	16	65	80
	135	5-1/4	16	65	80

D74-29 With Copper Middle Link

LOOSE RING BIT DOUBLE BROKEN COPPER MIDDLE LINK MOUTH (STAINLESS STEEL)

Article No.	Size (mm)	Size (Inch)	Thickness (mm)	Ring-ø (mm)	Box Qty.
D87	115	4-1/2	12	55	100
	125	5	12	65	100
	135	5-1/4	12	65	100

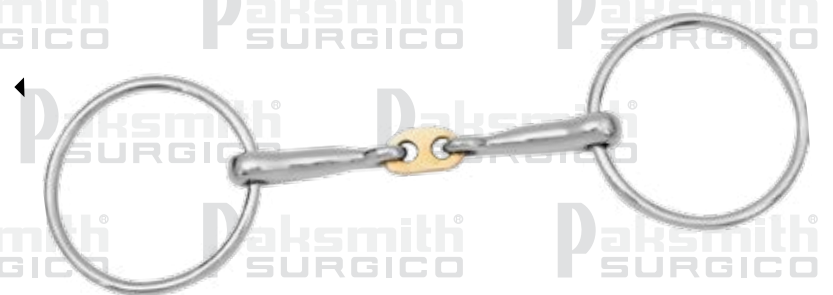

LOOSE RING BITS



LOOSE RING BIT SOLID CURVED RUBBER MOUTH (STAINLESS STEEL)

Article No.	Size (mm)	Size (Inch)	Thickness (mm)	Ring-ø (mm)	Box Qty.
D123	115	4-1/2	20	55	120
	125	5	20	65	120
	135	5-1/4	20	65	120

LOOSE RING BIT SOLID STRAIGHT RUBBER MOUTH (STAINLESS STEEL)

Article No.	Size (mm)	Size (Inch)	Thickness (mm)	Ring-ø (mm)	Box Qty.
D124	115	4-1/2	20	55	120
	125	5	20	65	120
	135	5-1/4	20	65	120
D124-7	125	5	20	3"	120



LOOSE RING BIT FLEXIBLE RUBBER MOUTH (STAINLESS STEEL)

Article No.	Size (mm)	Size (Inch)	Thickness (mm)	Ring-ø (mm)	Box Qty.
D03	115	4-1/2	20	55	120
	125	5	20	65	120
	135	5-1/4	20	65	120
D03-7	125	5	20	3"	120

LOOSE RING BIT SNAFFLE RUBBER MOUTH (STAINLESS STEEL)

Article No.	Size (mm)	Size (Inch)	Thickness (mm)	Ring-ø (mm)	Box Qty.
D04	115	4-1/2	20	55	100
	125	5	20	65	100
	135	5-1/4	20	65	100
D04-7	125	5	20	3"	100



LOOSE RING BIT SOLID SNAFFLE MOUTH (STAINLESS STEEL)

Article No.	Size (mm)	Size (Inch)	Thickness (mm)	Ring-ø (mm)	Box Qty.
D02	115	4-1/2	16 18	55	80
	125	5	16 18	65	80
	135	5-1/4	16 18	65	80
D02-701.NP	125	5	16 18	3"	80
D02-756.SS	125	5	16 18	3"	80

LOOSE RING BIT SNAFFLE HOLLOW MOUTH (STAINLESS STEEL)

Article No.	Size (mm)	Size (Inch)	Thickness (mm)	Ring-ø (mm)	Box Qty.
D62	115	4-1/2	16 18	55	140
	125	5	14 16 18 20	65	120
	135	5-1/4	14 16 18	65	120
D126	125	5	14 16 18 20	90	100
D128	125	5	18	100	100



You never got so much for so little

LOOSE RING BITS

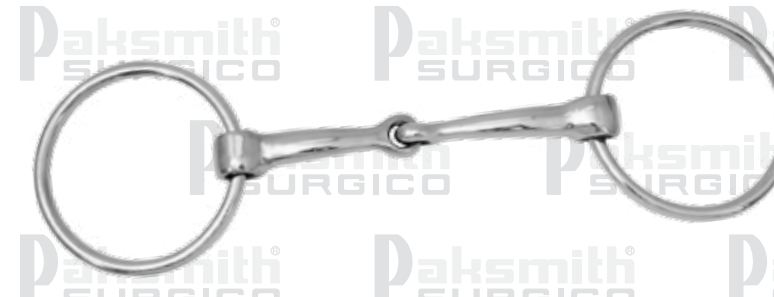

LOOSE RING BIT SNAFFLE MOUTH (STAINLESS STEEL)

Article No.	Size (mm)	Size (Inch)	Thickness (mm)	Ring-ø (mm)	Box Qty.
D05-56	115	4-1/2	12	55	100
D05-01.NP	125	5	12	65	100
	135	5-1/4	12	65	100

LOOSE RING BIT SNAFFLE CURVED COPPER INLAY MOUTH (STAINLESS STEEL)

Article No.	Size (mm)	Size (Inch)	Thickness (mm)	Ring-ø (mm)	Box Qty.
D94-29	115	4-1/2	12	55	120
	125	5	12	65	120
	135	5-1/4	12	65	120



LOOSE RING BIT SWEET IRON SNAFFLE COPPER INLAY MOUTH (STAINLESS STEEL)

Article No.	Size (mm)	Size (Inch)	Thickness (mm)	Ring-ø (mm)	Box Qty.
D10-86	115	4-1/2	12	55	120
	125	5	12	65	120
	135	5-1/4	12	65	120

LOOSE RING BIT SWEET IRON SNAFFLE COPPER INLAY MOUTH (STAINLESS STEEL)

Article No.	Size (mm)	Size (Inch)	Thickness (mm)	Ring-ø (mm)	Box Qty.
D30-86	115	4-1/2	10	55	120
	125	5	10	65	120
	135	5-1/4	10	65	120



LOOSE RING BIT SNAFFLE GERMAN SILVER MOUTH (STAINLESS STEEL)

Article No.	Size (mm)	Size (Inch)	Thickness (mm)	Ring-ø (mm)	Box Qty.
D02-88	105	4	16 18	55	80
	115	4-1/2	16 18	55	80
	125	5	16 18	65	80
	135	5-1/4	16 18	65	80

4 LOOSE RING BIT SNAFFLE MOUTH (GERMAN SILVER)

Article No.	Size (mm)	Size (Inch)	Thickness (mm)	Ring-ø (mm)	Box Qty.
D15-43	115	4-1/2	16 18	55	60
D15-56	125	5	16 18	65	60
	135	5-1/4	16 18	65	60



LOOSE RING BITS



FLAT LOOSE RING BIT SNAFFLE COPPER MOUTH (STAINLESS STEEL)

Article No.	Size (mm)	Size (Inch)	Thickness (mm)	Ring-ø (Inch)	Box Qty.
D07-29	115	4-1/2	12	3	60
	125	5	12	3	60
	135	5-1/4	12	3	60

D07-56 Available in complete Stainless Steel
D07-39 SS Ring with SW/Iron Mouth

FLAT LOOSE HAND ENGRAVED RING BIT SNAFFLE COPPER MOUTH (STAINLESS STEEL)

Article No.	Size (mm)	Size (Inch)	Thickness (mm)	Ring-ø (Inch)	Box Qty.
D07-E29	115	4-1/2	12	3	60
	125	5	12	3	60
	135	5-1/4	12	3	60



LOOSE TWISTED SS & COPPER WIRE RING BIT SNAFFLE COPPER MOUTH

Article No.	Size (mm)	Size (Inch)	Thickness (mm)	Ring-ø (Inch)	Box Qty.
D38-29	115	4-1/2	12	2-1/2	60
	125	5	12	3	60
	135	5-1/4	12	3	60

LOOSE RING BIT DOUBLE TWISTED WIRE MOUTH (STAINLESS STEEL)

Article No.	Size (mm)	Size (Inch)	Thickness (mm)	Ring-ø (mm)	Box Qty.
D09-56	115	4-1/2	16	65	150
D09-01.NP	125	5	16	65	150
	135	5-1/4	16	65	150



D09-29 Available in Copper Twisted Wire Mouth



LOOSE RING BIT TWISTED WIRE MOUTH (CS/NICKEL PLATED)

Article No.	Size (mm)	Size (Inch)	Thickness (mm)	Ring-ø (Inch)	Box Qty.
D129-01	125	5	8	3	150
	135	5-1/4	8	3	150
D139-01	115	PONY	8	2-1/2	200

LOOSE RING BIT SWEET IRON THIN TWISTED WIRE MOUTH (STAINLESS STEEL)

Article No.	Size (mm)	Size (Inch)	Thickness (mm)	Ring-ø (Inch)	Box Qty.
D08-7.39	125	5	6	3	200
	135	5-1/4	6	3	200



You never got so much for so little

LOOSE RING BITS



LOOSE RING BIT SNAFFLE TRI ANGLE GERMAN SILVER MOUTH (STAINLESS STEEL)

Article No.	Size (mm)	Size (Inch)	Thickness (mm)	Ring-ø (mm)	Box Qty.
D108-88	115	4-1/2	13	55	80
	125	5	13	65	80
	135	5-1/4	13	65	80

LOOSE RING BIT STRAIGHT RIBBED MOUTH (STAINLESS STEEL)

Article No.	Size (mm)	Size (Inch)	Thickness (mm)	Ring-ø (mm)	Box Qty.
D109	115	4-1/2	14	55	80
	125	5	14	65	80
	135	5-1/4	14	65	80



LOOSE RING BIT UP RIGHT MOUTH (STAINLESS STEEL)

Article No.	Size (mm)	Size (Inch)	Thickness (mm)	Ring-ø (Inch)	Box Qty.
D95	115	4-1/2	16	3	80
	125	5	16	3	80
	135	5-1/4	16	3	80

LOOSE RING BIT SNAFFLE MOUTH (GERMAN SILVER)

Article No.	Size (mm)	Size (Inch)	Thickness (mm)	Ring-ø (mm)	Box Qty.
D01-43	125	5	18	65	80
	135	5-1/4	18	65	80



LOOSE RING BIT DOUBLE BROKEN MOUTH (STAINLESS STEEL)

Article No.	Size (mm)	Size (Inch)	Thickness (mm)	Ring-ø (mm)	Box Qty.
D86	115	4-1/2	16	55	80
	125	5	16	65	80
	135	5-1/4	16	65	80

4 LOOSE RING BIT SNAFFLE COPPER MOUTH (STAINLESS STEEL)

Article No.	Size (mm)	Size (Inch)	Thickness (mm)	Ring-ø (mm)	Box Qty.
D113	125	5	10	65	80
	135	5-1/4	10	65	80



LOOSE RING BITS



RING BIT WITH MIDDLE RING, SNAFFLE RUBBER MOUTH (STAINLESS STEEL)

Article No.	Size (mm)	Size (Inch)	Thickness (mm)	Ring-ø (Inch)	Box Qty.
D48	115	4-1/2	20	2-1/2	80
	125	5	20	2-1/2	80
	135	5-1/4	20	2-1/2	80

RING BIT WITH MIDDLE RING, SNAFFLE MOUTH (STAINLESS STEEL)

Article No.	Size (mm)	Size (Inch)	Thickness (mm)	Ring-ø (Inch)	Box Qty.
D49-56	115	4-1/2	16	2-1/2	80
	125	5	16	2-1/2	80
	135	5-1/4	16	2-1/2	80



RING BIT WITH MIDDLE RING, SNAFFLE HOLLOW MOUTH (STAINLESS STEEL)

Article No.	Size (mm)	Size (Inch)	Thickness (mm)	Ring-ø (mm)	Box Qty.
D49-03	115	4-1/2	18	65	100
	125	5	18	65	100
	135	5-1/4	18	65	100

C-RING BIT, DOG BONE LINK MOUTH (STAINLESS STEEL)

Article No.	Size (mm)	Size (Inch)	Thickness (mm)	Ring-ø (Inch)	Box Qty.
D53	115	4-1/2	10	2-1/2	100
	125	5	10	2-1/2	100
D115-56	Snaffle Mouth		10	2-1/2	100



C-RING BIT, DOG BONE LINK TWISTED WIRE MOUTH (STAINLESS STEEL)

Article No.	Size (mm)	Size (Inch)	Thickness (mm)	Ring-ø (Inch)	Box Qty.
D56	115	4-1/2	10	2-1/2	100
	125	5	10	2-1/2	100
	135	5-1/4	10	2-1/2	100

LOOSE HEAVY RING BIT SNAFFLE MOUTH (CS/NICKEL PLATED)

Article No.	Size (mm)	Size (Inch)	Thickness (mm)	Ring-ø (mm)	Box Qty.
D112	125	5	14	65	60
	135	5-1/4	14	65	60



You never got so much for so little

LOOSE RING BITS



LOOSE RING BIT 3 PC TONGUE PRESS SWIVEL MOUTH (STAINLESS STEEL)

Article No.	Size (mm)	Size (Inch)	Thickness (mm)	Ring-ø (mm)	Box Qty.
D114	115	4-1/2	14	55	80
	125	5	14	65	80
	135	5-1/4	14	65	80

LOOSE RING BIT GERMAN SILVER TONGUE PRESS MOUTH (STAINLESS STEEL)

Article No.	Size (mm)	Size (Inch)	Thickness (mm)	Ring-ø (mm)	Box Qty.
D64-88	115	4-1/2	12	55	80
	125	5	12	65	80
	135	5-1/4	12	65	80



LOOSE RING BIT CHAIN MOUTH (CS/BRASS PLATED)

Article No.	Size (mm)	Size (Inch)	Thickness (mm)	Ring-ø (mm)	Box Qty.
D111-04	125	5	10	65	120
	135	5-1/4	10	65	120

LOOSE RING BIT SNAFFLE MOUTH (STAINLESS STEEL)

Article No.	Size (mm)	Size (Inch)	Thickness (mm)	Ring-ø (mm)	Box Qty.
D01-56	115	4-1/2	13	18	65
	125	5	13	18	65
D01-88	125	5	13	18	65
D131-56	110	PONY	12	40	120

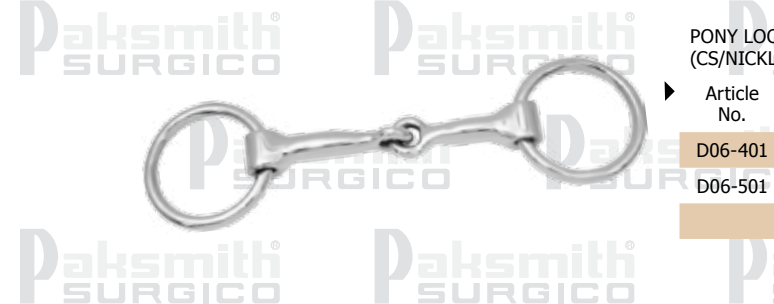

PONY LOOSE RING BIT SNAFFLE MOUTH (CS/NICKLE PLATED)

Article No.	Size (mm)	Size (Inch)	Thickness (mm)	Ring-ø (mm)	Box Qty.
D06-401	105	4	12	45	120
D06-501	115	4-1/2	12	50	120
	125	5	12	50	120
	175	6-1/2	12	50	100

PONY LOOSE RING BIT BROKEN LINK GERMAN SILVER MOUTH (STAINLESS STEEL)

Article No.	Size (mm)	Size (Inch)	Thickness (mm)	Ring-ø (mm)	Box Qty.
D96-88	105	4	12	50	120
	115	4-1/2	12	50	120



PONY RING BIT SNAFFLE MOUTH ROUND TYPE (STAINLESS STEEL)

Article No.	Size (mm)	Size (Inch)	Thickness (mm)	Ring-ø (mm)	Box Qty.
D36-56	95	3-3/4	10	40	150
D36-01.NP	105	4	14	40	150
	115	4-1/2	14	40	120
	125	5	14	40	120
	135	5-1/4	14	40	120



LOOSE RING BITS



LOOSE RING BIT BLUE IRON COPPER ROLLER 3PC MOUTH (STAINLESS STEEL)

Article No.	Size (mm)	Size (Inch)	Thickness (mm)	Ring-ø (mm)	Box Qty.
D150-38	115	4-1/2	12	65	80
	125	5	12	65	80
	135	5-1/4	12	65	80

LOOSE RING BIT TRIANGLE GERMAN SILVER MOUTH (STAINLESS STEEL)

Article No.	Size (mm)	Size (Inch)	Thickness (mm)	Ring-ø (mm)	Box Qty.
D151-88	115	4-1/2	12	65	80
	125	5	12	65	80
	135	5-1/4	12	65	80



LOOSE RING BIT DEGREE GERMAN SILVER MOUTH (STAINLESS STEEL)

Article No.	Size (mm)	Size (Inch)	Thickness (mm)	Ring-ø (mm)	Box Qty.
D152-88	115	4-1/2	12	65	80
	125	5	12	65	80
	135	5-1/4	12	65	80



LOOSE RING BIT DOWN DEGREE GERMAN SILVER MOUTH (STAINLESS STEEL)

Article No.	Size (mm)	Size (Inch)	Thickness (mm)	Ring-ø (mm)	Box Qty.
D153-88	115	4-1/2	12	65	80
	125	5	12	65	80
	135	5-1/4	12	65	80



LOOSE RING BIT 3 LINKS GERMAN SILVER MOUTH (STAINLESS STEEL)

Article No.	Size (mm)	Size (Inch)	Thickness (mm)	Ring-ø (mm)	Box Qty.
D154-88	115	4-1/2	15	65	80
	125	5	15	65	80
	135	5-1/4	15	65	80



DEE RING BIT, SNAFFLE HOLLOW MOUTH (STAINLESS STEEL)

Article No.	Size (mm)	Size (Inch)	Thickness (mm)	Ring-ø (Inch)	Box Qty.
D103-03	115	4-1/2	20	3	80
	125	5	20	3	80
	135	5-1/4	20	3	80



You never got so much for so little

DOUBLE RING BITS



DOUBLE RING BIT SWEET IRON TWISTED WIRE 3-PC MOUTH (STAINLESS STEEL)

Article No.	Size (mm)	Size (Inch)	Thickness (mm)	Ring-ø (Inch)	Box Qty.
D12-39	115	4-1/2	8	3	80
	125	5	8	3	80
	135	5-1/4	8	3	80

DOUBLE RING BIT SWEET IRON SNAFFLE MOUTH (STAINLESS STEEL)

Article No.	Size (mm)	Size (Inch)	Thickness (mm)	Ring-ø (Inch)	Box Qty.
D13-39	115	4-1/2	8	3	80
	125	5	8	3	80
	135	5-1/4	8	3	80



DOUBLE RING BIT BRASS SNAFFLE COPPER WIRE WRAPPED MOUTH (STAINLESS STEEL)

Article No.	Size (mm)	Size (Inch)	Thickness (mm)	Ring-ø (Inch)	Box Qty.
D31-36	115	4-1/2	12	3	80
	125	5	12	3	80
	135	5-1/4	12	3	80



DOUBLE RING BIT SNAFFLE MOUTH (STAINLESS STEEL)

Article No.	Size (mm)	Size (Inch)	Thickness (mm)	Ring-ø (Inch)	Box Qty.
D32-56	115	4-1/2	12	3	80
	125	5	12	3	80
	135	5-1/4	12	3	80



TWO RING GAG BIT SWEET IRON TWISTED WIRE 3-PC MOUTH (STAINLESS STEEL)

Article No.	Size (mm)	Size (Inch)	Thickness (mm)	Ring-ø (Inch)	Box Qty.
D41-39	115	4-1/2	10	3	80
	125	5	10	3	80
	135	5-1/4	10	3	80



ANTI REARING BITS



ANTI REARING CHIFNEY BIT MOUTH
(Stainless Steel)

Article No.	Size (mm)	Size (Inch)	Thickness (mm)	Ring-ø (Inch)	Box Qty.
D55-56	115	4-1/2	7 8	1	100
	125	5	7 8	1	100

ANTI REARING CHIFNEY BIT MOUTH
(Stainless Steel)

Article No.	Size (mm)	Size (Inch)	Thickness (mm)	Ring-ø (Inch)	Box Qty.
D54-56	115	4-1/2	7 8	1	100
	125	5	7 8	1	100

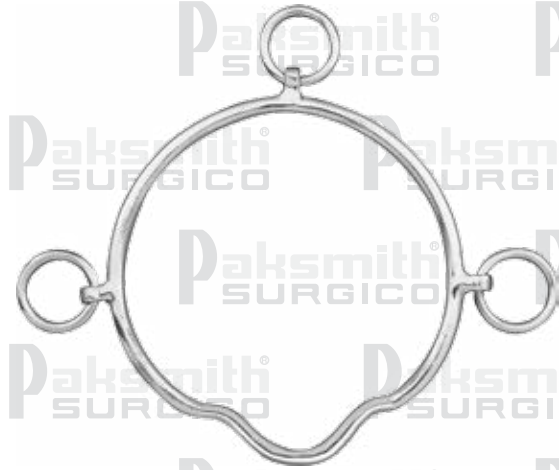

ANTI REARING CHIFNEY BIT MOUTH
(Stainless Steel)

Article No.	Size (mm)	Size (Inch)	Thickness (mm)	Ring-ø (Inch)	Box Qty.
D127-56	115	4-1/2	7 8	1	100
	125	5	7 8	1	100

MOUTH PIECE 3 RINGS
(Stainless Steel)

Article No.	Size (mm)	Size (Inch)	Thickness (mm)	Ring-ø (Inch)	Box Qty.
K08-56	125	5	6	1	200



NOSE RING WIRE WITH 2 RINGS
(Stainless Steel)

Article No.	Size	Box Qty.
K07-56	Standard	400

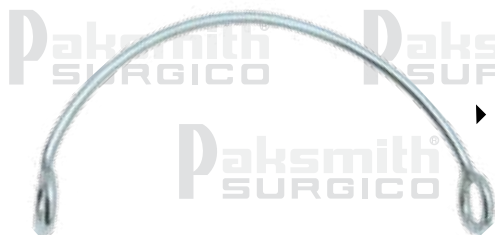

CRIBBING LATCH
(Brass)

Article No.	Material	Box Qty.
K06-33	Brass	40
K06-51	Aluminum	60



NOSE BAND
(Stainless Steel)

Article No.	Size	Box Qty.
B15-56	Standard	100



EGG BITS

EGG BUTT BITS



EGG BUTT SNAFFLE COPPER MOUTH (STAINLESS STEEL)

Article No.	Size (mm)	Size (Inch)	Thickness (mm)	Ring-ø (Inch)	Box Qty.
D26-29	115	4-1/2	12	2-1/2	70
	125	5	12	2-1/2	70
	135	5-1/4	12	2-1/2	70
	145	5-3/4	12	2-1/2	70
D26-03	Available in Hollow Mouth Stainless Steel				
D26-56	Available in complete Stainless Steel				

HAND ENGRAVED EGG BUTT SNAFFLE MOUTH (STAINLESS STEEL)

Article No.	Size (mm)	Size (Inch)	Thickness (mm)	Ring-ø (Inch)	Box Qty.
D26-E	115	4-1/2	12	2-1/2	70
	125	5	12	2-1/2	70
	135	5-1/4	12	2-1/2	70



EGG BUTT WIRE MADE RING SNAFFLE MOUTH (STAINLESS STEEL)

Article No.	Size (mm)	Size (Inch)	Thickness (mm)	Ring-ø (Inch)	Box Qty.
D28-56	115	4-1/2	12	2-1/2	80
	125	5	12	2-1/2	80
D28-43	135	5-1/4	12	2-1/2	80



EGG BUTT WIRE MADE RING BROKEN COPPER NUT HOLLOW MOUTH (STAINLESS STEEL)

Article No.	Size (mm)	Size (Inch)	Thickness (mm)	Ring-ø (Inch)	Box Qty.
D134-03	115	4-1/2	18	2-1/2	100
	125	5	18	2-1/2	100
	135	5-1/4	18	2-1/2	100



EGG BUTT WIRE MADE RING SNAFFLE HOLLOW MOUTH (STAINLESS STEEL)

Article No.	Size (mm)	Size (Inch)	Thickness (mm)	Ring-ø (mm)	Box Qty.
D130-03	115	4-1/2	20	70	100
	125	5	20	70	100
	135	5-1/4	20	70	100
	145	5-3/4	20	70	100



EGG BUTT SS MIDDLE LINK HOLLOW MOUTH (STAINLESS STEEL)

Article No.	Size (mm)	Size (Inch)	Thickness (mm)	Ring-ø (Inch)	Box Qty.
D77-03	115	4-1/2	16	2-1/2	100
	125	5	16	2-1/2	100
	135	5-1/4	16	2-1/2	100



Our Quality is hard to beat

EGG BUTT BITS



HAND ENGRAVED EGG BUTT SNAFFLE MOUTH (GERMAN SILVER)

Article No.	Size (mm)	Size (Inch)	Thickness (mm)	Ring-ø (Inch)	Box Qty.
D34-E43	115	4-1/2	16	2-1/2	50
	125	5	16	2-1/2	50
	135	5-1/4	16	2-1/2	50
D43-43	Without Engraving				

EGG BUTT WIRE MADE RING SNAFFLE MOUTH (STAINLESS STEEL)

Article No.	Size (mm)	Size (Inch)	Thickness (mm)	Ring-ø (Inch)	Box Qty.
D79-56	115	4-1/2	14	2-1/2	80
	125	5	14	2-1/2	80
	135	5-1/4	14	2-1/2	80



EGG BUTT WIRE MADE RING GERMAN SILVER SNAFFLE MOUTH (STAINLESS STEEL)

Article No.	Size (mm)	Size (Inch)	Thickness (mm)	Ring-ø (Inch)	Box Qty.
D79-88	115	4-1/2	14	2-1/2	80
	125	5	14	2-1/2	80
	135	5-1/4	14	2-1/2	80

EGG BUTT WIRE MADE RING SNAFFLE RUBBER MOUTH (STAINLESS STEEL)

Article No.	Size (mm)	Size (Inch)	Thickness (mm)	Ring-ø (Inch)	Box Qty.
D116	115	4-1/2	20	2-1/2	80
	125	5	20	2-1/2	80
	135	5-1/4	20	2-1/2	80



EGG BUTT WIRE MADE RING SNAFFLE MOUTH (STAINLESS STEEL)

Article No.	Size (mm)	Size (Inch)	Thickness (mm)	Ring-ø (Inch)	Box Qty.
D100-56	115	4-1/2	14	2-1/2	80
	125	5	14	2-1/2	80
	135	5-1/4	14	2-1/2	80

EGG BUTT FLAT RING GERMAN SILVER MIDDLE LINK MOUTH (STAINLESS STEEL)

Article No.	Size (mm)	Size (Inch)	Thickness (mm)	Ring-ø (Inch)	Box Qty.
D101-88	115	4-1/2	14	2-1/2	80
	125	5	14	2-1/2	80
	135	5-1/4	14	2-1/2	80



EGG BUTT BITS



EGG BUTT WIRE MADE RING DOG BONE LINK MOUTH (STAINLESS STEEL)

Article No.	Size (mm)	Size (Inch)	Thickness (mm)	Ring-ø (Inch)	Box Qty.
D160-56	115	4-1/2	14	2-1/2	80
	125	5	14	2-1/2	80
	135	5-1/4	14	2-1/2	80

EGG BUTT WIRE MADE RING GERMAN SILVER MIDDLE LINK MOUTH (STAINLESS STEEL)

Article No.	Size (mm)	Size (Inch)	Thickness (mm)	Ring-ø (Inch)	Box Qty.
D98-88	115	4-1/2	14	2-1/2	80
	125	5	14	2-1/2	80
	135	5-1/4	14	2-1/2	80



EGG BUTT WIRE MADE RING MIDDLE LINK MOUTH (STAINLESS STEEL)

Article No.	Size (mm)	Size (Inch)	Thickness (mm)	Ring-ø (Inch)	Box Qty.
D80-56	115	4-1/2	16	2-1/2	80
	125	5	16	2-1/2	80
	135	5-1/4	16	2-1/2	80

EGG BUTT, SNAFFLE QUARTER MOON MOUTH (STAINLESS STEEL)

Article No.	Size (mm)	Size (Inch)	Thickness (mm)	Ring-ø (Inch)	Box Qty.
D57-56	115	4-1/2	14	2-1/2	80
	125	5	14	2-1/2	80
	135	5-1/4	14	2-1/2	80



EGG BUTT MIDDLE LINK COPPER ROLLER MOUTH (STAINLESS STEEL)

Article No.	Size (mm)	Size (Inch)	Thickness (mm)	Ring-ø (Inch)	Box Qty.
D58-29	115	4-1/2	14	2-1/2	80
	125	5	14	2-1/2	80
	135	5-1/4	14	2-1/2	80

EGG BUTT FLAT CURVED LINK MOUTH (STAINLESS STEEL)

Article No.	Size (mm)	Size (Inch)	Thickness (mm)	Ring-ø (Inch)	Box Qty.
D75-56	115	4-1/2	14	2-1/2	80
	125	5	14	2-1/2	80
	135	5-1/4	14	2-1/2	80



Our Quality is hard to beat

EGG BUTT BITS



EGG BUTT BLUE SNAFFLE MOUTH (STAINLESS STEEL)

Article No.	Size (mm)	Size (Inch)	Thickness (mm)	Ring-ø (Inch)	Box Qty.
D155-38	115	4-1/2	16	2-1/2	80
	125	5	16	2-1/2	80
	135	5-1/4	16	2-1/2	80

EGG BUTT BLUE DOUBLE BROKEN MOUTH (STAINLESS STEEL)

Article No.	Size (mm)	Size (Inch)	Thickness (mm)	Ring-ø (Inch)	Box Qty.
D156-38	115	4-1/2	16	2-1/2	80
	125	5	16	2-1/2	80
	135	5-1/4	16	2-1/2	80



EGG BUTT WIRE MADE RING TRIANGLE GERMAN SILVER MOUTH (STAINLESS STEEL)

Article No.	Size (mm)	Size (Inch)	Thickness (mm)	Ring-ø (Inch)	Box Qty.
D157-88	115	4-1/2	12	2-1/2	80
	125	5	12	2-1/2	80
	135	5-1/4	12	2-1/2	80

EGG BUTT SWEET IRON SNAFFLE MOUTH (STAINLESS STEEL)

Article No.	Size (mm)	Size (Inch)	Thickness (mm)	Ring-ø (Inch)	Box Qty.
D99-39	115	4-1/2	12	2-1/2	70
	125	5	12	2-1/2	70
	135	5-1/4	12	2-1/2	70



EGG BUTT DEGREE DOUBLE BROKEN GERMAN SILVER MOUTH (STAINLESS STEEL)

Article No.	Size (mm)	Size (Inch)	Thickness (mm)	Ring-ø (Inch)	Box Qty.
D158-88	115	4-1/2	12	2-1/2	80
	125	5	12	2-1/2	80
	135	5-1/4	12	2-1/2	80

EGG BUTT DEGREE DOUBLE BROKEN GERMAN SILVER MOUTH (STAINLESS STEEL)

Article No.	Size (mm)	Size (Inch)	Thickness (mm)	Ring-ø (Inch)	Box Qty.
D159-88	115	4-1/2	14	2-1/2	80
	125	5	14	2-1/2	80
	135	5-1/4	14	2-1/2	80



EGG BUTT BITS



EGG BUTT SNAFFLE MOUTH (STAINLESS STEEL)

Article No.	Size (mm)	Size (Inch)	Thickness (mm)	Ring-ø (mm)	Box Qty.
D81	115	4-1/2	14	45	100
	125	5	14	45	100
	135	5-1/4	14	45	100

EGG BUTT WIRE MADE RING SNAFFLE HOLLOW MOUTH (STAINLESS STEEL)

Article No.	Size (mm)	Size (Inch)	Thickness (mm)	Ring-ø (mm)	Box Qty.
D66	115	4-1/2	16	18	50
	125	5	16	18	60
	135	5-1/4	16	18	60
	145	5-1/2	16	18	60
D166-56	Solid Snaffle 12mm Mouth Available				100



PONY EGG BUTT WIRE MADE RING GERMAN SILVER BROKEN LINK MOUTH (STAINLESS STEEL)

Article No.	Size (mm)	Size (Inch)	Thickness (mm)	Ring-ø (mm)	Box Qty.
D118-88	115	4-1/2	14	45	100
	125	5	14	45	100

PONY EGG BUTT WIRE MADE RING BROKEN LINK MOUTH (STAINLESS STEEL)

Article No.	Size (mm)	Size (Inch)	Thickness (mm)	Ring-ø (mm)	Box Qty.
D118-56	115	4-1/2	14	45	100
	125	5	14	45	100



PONY EGG BUTT WIRE MADE RING SNAFFLE MOUTH (STAINLESS STEEL)

Article No.	Size (mm)	Size (Inch)	Thickness (mm)	Ring-ø (mm)	Box Qty.
D97-56	115	4-1/2	12	45	100
	125	5	12	45	100



PONY EGG BUTT SNAFFLE MOUTH (STAINLESS STEEL)

Article No.	Size (mm)	Size (Inch)	Thickness (mm)	Ring-ø (mm)	Box Qty.
D29-56	70	2-3/4	8	40	150
	100	4	10	40	150
	115	4-1/2	10	40	150



EGG BUTT BITS
DEE FEES

DEE RING BITS

Paksmith
SURGICO



DEE RING BIT, COPPER & SS ROLLER MOUTH
(STAINLESS STEEL)

Article No.	Size (mm)	Size (Inch)	Thickness (mm)	Ring-ø (Inch)	Box Qty.
D19-29	115	4-1/2	14	3	80
	125	5	14	3	80
	135	5-1/4	14	3	80

DEE RING BIT SNAFFLE COPPER MOUTH
(STAINLESS STEEL)

Article No.	Size (mm)	Size (Inch)	Thickness (mm)	Ring-ø (Inch)	Box Qty.
D20-29	115	4-1/2	14	3	80
D20-56.SS	125	5	14	3	80
	135	5-1/4	14	3	80
D20-01.NP	120	4-3/4	14	2-7/8	80

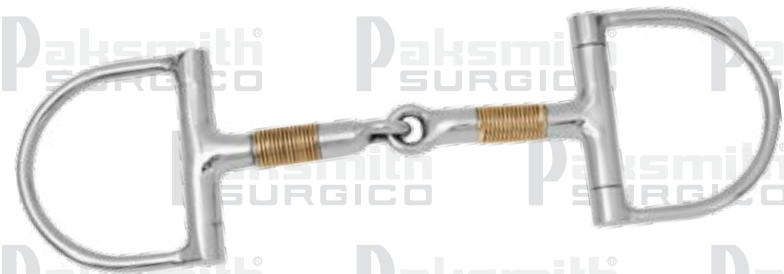

DEE RING BIT COPPER WIRE WRAPPED MOUTH
(STAINLESS STEEL)

Article No.	Size (mm)	Size (Inch)	Thickness (mm)	Ring-ø (Inch)	Box Qty.
D23-29	115	4-1/2	14	2-1/2	80
	125	5	14	2-1/2	80
	135	5-1/4	14	2-1/2	80

DEE RING BIT, TRIANGLE MOUTH
(STAINLESS STEEL)

Article No.	Size (mm)	Size (Inch)	Thickness (mm)	Ring-ø (Inch)	Box Qty.
D24-56	115	4-1/2	14	2-1/2	80
	125	5	14	2-1/2	80
	135	5-1/4	14	2-1/2	80



BIG DEE RING BIT SNAFFLE MOUTH
(STAINLESS STEEL)

Article No.	Size (mm)	Size (Inch)	Thickness (mm)	Ring-ø (Inch)	Box Qty.
D102-56	115	4-1/2	14	3	80
	125	5	14	3	80
	135	5-1/4	14	3	80

DEE RING BIT, SNAFFLE HOLLOW MOUTH
(STAINLESS STEEL)

Article No.	Size (mm)	Size (Inch)	Thickness (mm)	Ring-ø (mm)	Box Qty.
D68-03	125	5	22	65	100
	135	5-1/4	22	65	100



Best products with best prices

DEE RING BITS



O-RING BIT, FORWARD ROLLER COPPER RINGS MOUTH
(STAINLESS STEEL)

Article No.	Size (mm)	Size (Inch)	Thickness (mm)	Ring-ø (Inch)	Box Qty.
D119-56	115	4-1/2	14	2-1/2	80
	125	5	14	2-1/2	80
	135	5-1/4	14	2-1/2	80

O-RING BIT, SNAFFLE TRI ANGLE MOUTH
(STAINLESS STEEL)

Article No.	Size (mm)	Size (Inch)	Thickness (mm)	Ring-ø (Inch)	Box Qty.
D120	115	4-1/2	13	2-1/2	80
	125	5	13	2-1/2	80
	135	5-1/4	13	2-1/2	80



O-RING BIT, THIN TWISTED WIRE MOUTH
(STAINLESS STEEL)

Article No.	Size (mm)	Size (Inch)	Thickness (mm)	Ring-ø (Inch)	Box Qty.
D25-56	115	4-1/2	10	2-1/2	80
	125	5	10	2-1/2	80
	135	5-1/4	10	2-1/2	80

D25-29 With Copper Twisted wire mouth

O-RING BIT, SWEET IRON THICK TWISTED WIRE
MOUTH (STAINLESS STEEL)

Article No.	Size (mm)	Size (Inch)	Thickness (mm)	Ring-ø (Inch)	Box Qty.
D46-39	115	4-1/2	10	2-1/2	80
	125	5	10	2-1/2	80
	135	5-1/4	10	2-1/2	80



O-RING BIT, SWEET IRON SNAFFLE COPPER INLAY
MOUTH (STAINLESS STEEL)

Article No.	Size (mm)	Size (Inch)	Thickness (mm)	Ring-ø (Inch)	Box Qty.
D27-39	115	4-1/2	11	2-1/2	80
	125	5	11	2-1/2	80
	135	5-1/4	11	2-1/2	80

D27-56 Available in complete Stainless Steel

DEE RING BIT SNAFFLE RUBBER MOUTH
(CS/CHROME PLATED)

Article No.	Size (mm)	Size (Inch)	Thickness (mm)	Ring-ø (Inch)	Box Qty.
D60-02	115	4-1/2	21	2-7/8	3
	125	5	21	2-7/8	3
	135	5-1/4	21	2-7/8	3



DEE RING BITS



DEE RING BIT, COPPER MIDDLE LINK RUBBER MOUTH (STAINLESS STEEL)

Article No.	Size (mm)	Size (Inch)	Thickness (mm)	Ring-ø (Inch)	Box Qty.
D76-56	115	4-1/2	21	2-7/8	80
	125	5	21	2-7/8	80
	135	5-1/4	21	2-7/8	80

O-RING BIT SNAFFLE COPPER INLAY MOUTH (SWEET IRON)

Article No.	Size (mm)	Size (Inch)	Thickness (mm)	Ring-ø (mm)	Box Qty.
D132-86	115	4-1/2	12	65	80
	125	5	12	65	80
	135	5-1/4	12	65	80

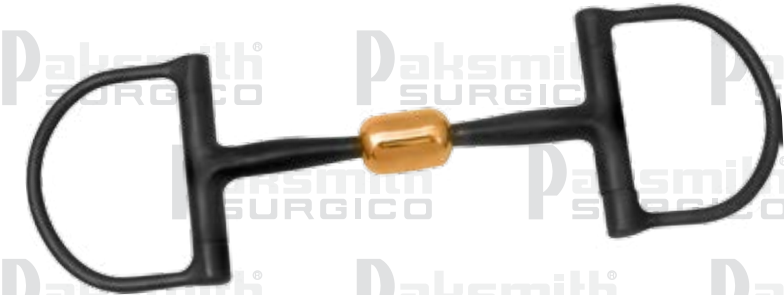

DEE RING BIT BILLY ALLEN COPPER ROLLER MOUTH (SWEET IRON)

Article No.	Size (mm)	Size (Inch)	Thickness (mm)	Ring-ø (Inch)	Box Qty.
D18-86	115	4-1/2	12	3	80
	125	5	12	3	80
	135	5-1/4	12	3	80

O-RING BIT BILLY ALLEN COPPER ROLLER MOUTH (SWEET IRON)

Article No.	Size (mm)	Size (Inch)	Thickness (mm)	Ring-ø (Inch)	Box Qty.
D44-86	115	4-1/2	12	2-1/2	80
	125	5	12	2-1/2	80
	135	5-1/4	12	2-1/2	80

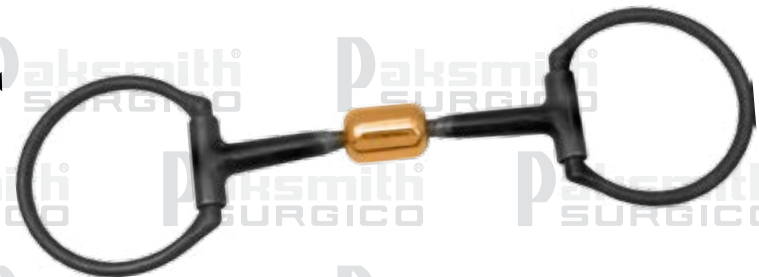

O-RING BIT SNAFFLE COPPER INLAY MOUTH (SWEET IRON)

Article No.	Size (mm)	Size (Inch)	Thickness (mm)	Ring-ø (Inch)	Box Qty.
D22-87	115	4-1/2	12	2-1/2	80
	125	5	12	2-1/2	80
	135	5-1/4	12	2-1/2	80

DEE RING BIT SNAFFLE COPPER INLAY MOUTH (SWEET IRON)

Article No.	Size (mm)	Size (Inch)	Thickness (mm)	Ring-ø (Inch)	Box Qty.
D14-87	115	4-1/2	12	3	80
	125	5	12	3	80
	135	5-1/4	12	3	80

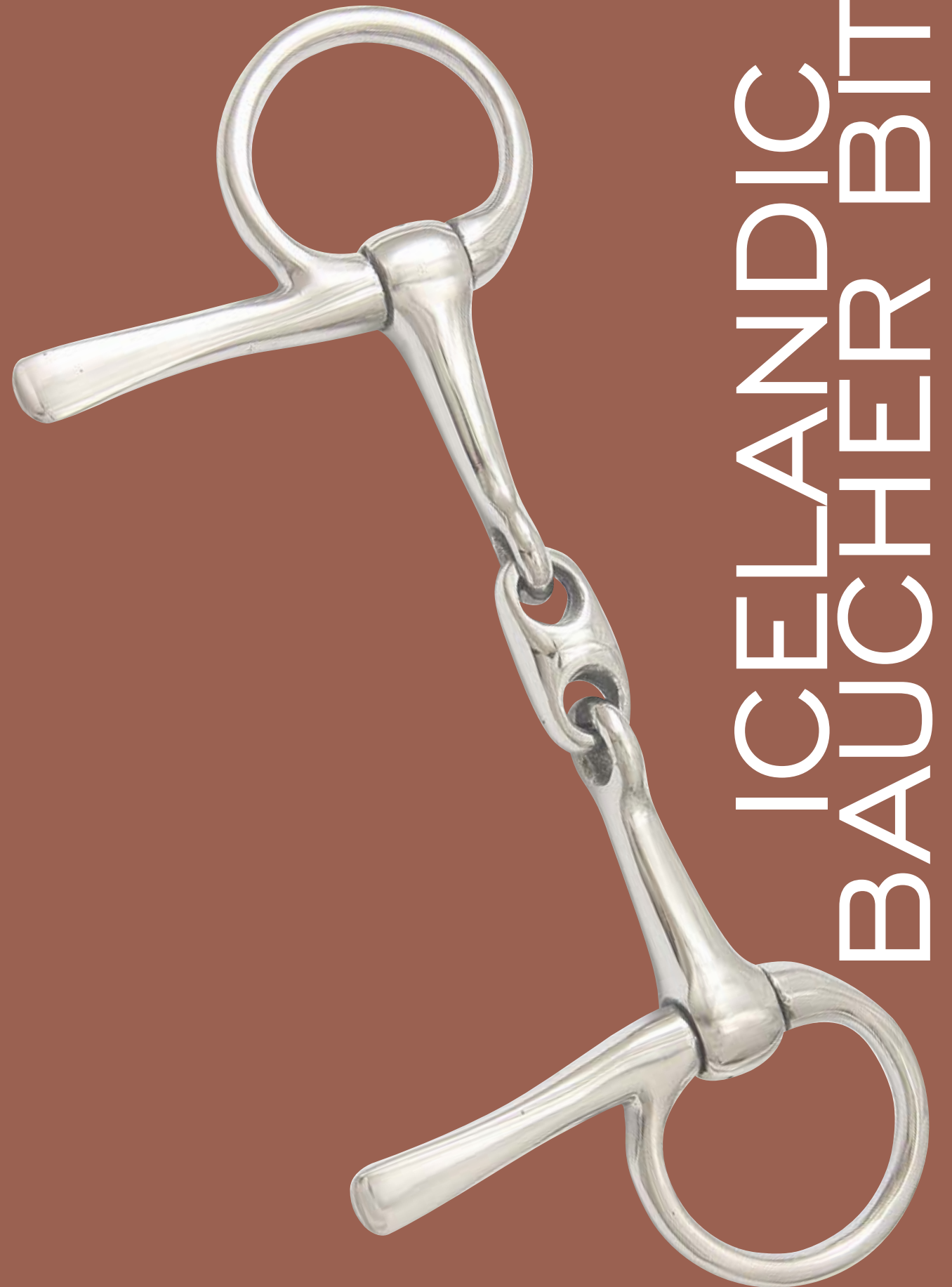

ICE LANDIC & BAUCHERER BITS

ICELANDIC RING BITS



▶ DRIVING BIT DOUBLE BROKEN MOUTH (STAINLESS STEEL)

Article No.	Size (mm)	Size (Inch)	Thickness (mm)	Ring-ø (mm)	Box Qty.
D105	115	4-1/2	14	40	60
	125	5	14	40	60
	135	5-1/4	14	40	60

DRIVING BIT SNAFFLE MOUTH (STAINLESS STEEL)

Article No.	Size (mm)	Size (Inch)	Thickness (mm)	Ring-ø (Inch)	Box Qty.
D33	95	3-3/4	16	1-3/4	70
	115	4-1/2	16	1-3/4	70
	125	5	16	1-3/4	70
	135	5-1/4	16	1-3/4	70
D33-0	Leather Covered Mouth				
D33-29	Available with Copper mouth				

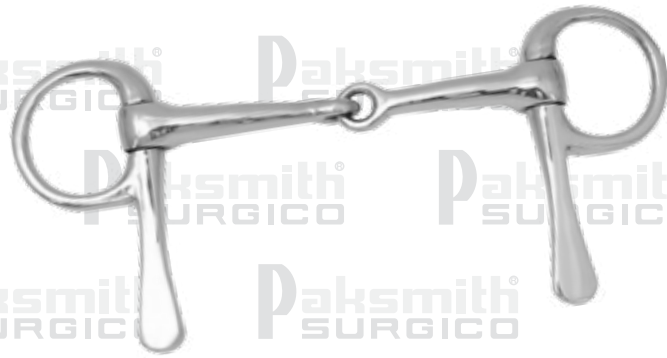

▶ DRIVING BIT SNAFFLE PINCH-LESS MOUTH (STAINLESS STEEL)

Article No.	Size (mm)	Size (Inch)	Thickness (mm)	Ring-ø (Inch)	Box Qty.
D35	115	4-1/2	18	1-3/4	60
	125	5	18	1-3/4	60
	135	5-1/4	18	1-3/4	60
D35-0	Leather Covered Mouth				

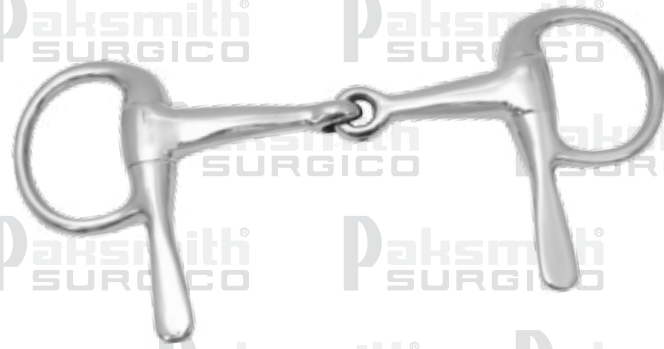

DRIVING BIT MULLEN MOUTH (STAINLESS STEEL)

Article No.	Size (mm)	Size (Inch)	Thickness (mm)	Ring-ø (Inch)	Box Qty.
D42	115	4-1/2	16	1-3/4	70
	125	5	16	1-3/4	70
	135	5-1/4	16	1-3/4	70
D42-1	Leather Covered Mouth				

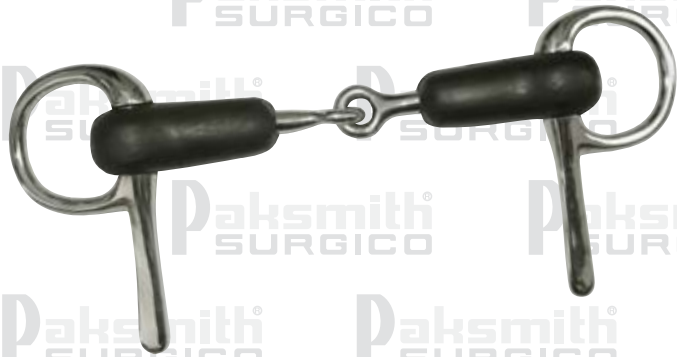
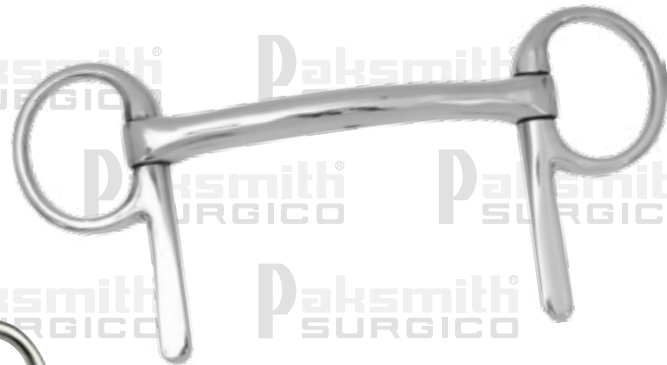

▶ DRIVING BIT SNAFFLE RUBBER MOUTH (STAINLESS STEEL)

Article No.	Size (mm)	Size (Inch)	Thickness (mm)	Ring-ø (mm)	Box Qty.
D120	125	5	20	40	70
	135	5-1/4	20	40	70

DRIVING BIT SNAFFLE MOUTH WITH BIGGER RING (STAINLESS STEEL)

Article No.	Size (mm)	Size (Inch)	Thickness (mm)	Ring-ø (Inch)	Box Qty.
D106	125	5	14	1-3/4	60
	135	5-1/4	14	1-3/4	60



Quality creates demand

ICELANDIC RING BITS



ICELANDIC 18cm CHEEK, SNAFFLE MOUTH WITH SINGLE CURB CHAIN (STAINLESS STEEL)

Article No.	Size (mm)	Size (Inch)	Thickness (mm)	Ring-ø (mm)	Box Qty.
C20-56	115	4-1/2	12	45	50
	125	5	12	45	50
	135	5-1/4	12	45	50

ICELANDIC 18cm CHEEK, BROKEN COPPER LINK MOUTH WITH SINGLE CURB CHAIN (STAINLESS STEEL)

Article No.	Size (mm)	Size (Inch)	Thickness (mm)	Ring-ø (mm)	Box Qty.
C53-29	115	4-1/2	12	45	50
	125	5	12	45	50
	135	5-1/4	12	45	50



ICELANDIC 18cm CHEEK, HIGH PORT JOINTED MOUTH WITH SINGLE CURB CHAIN (STAINLESS STEEL)

Article No.	Size (mm)	Size (Inch)	Thickness (mm)	Ring-ø (mm)	Box Qty.
C50	115	4-1/2	12	45	50
	125	5	12	45	50
	135	5-1/4	12	45	50

REGULATOR BIT LEATHER COVERED MOUTH (STAINLESS STEEL)

Article No.	Size (mm)	Size (Inch)	Thickness (mm)	Ring-ø (mm)	Box Qty.
D121	115	4-1/2	22	65	50
	125	5	22	65	50
	135	5-1/4	22	65	50



REGULATOR BIT RUBBER COVERED MOUTH (STAINLESS STEEL)

Article No.	Size (mm)	Size (Inch)	Thickness (mm)	Ring-ø (mm)	Box Qty.
D122	115	4-1/2	22	65	50
	125	5	22	65	50
	135	5-1/4	22	65	50

DRIVING REGULATOR BIT LEATHER COVERED MOUTH (STAINLESS STEEL)

Article No.	Size (mm)	Size (Inch)	Thickness (mm)	Ring-ø (mm)	Box Qty.
D50	115	4-1/2	20	65	50
	125	5	20	65	50
	135	5-1/4	20	65	50



BAUCHER RING BITS



BAUCHER BIT MEDIUM PORT MOUTH WITH DOUBLE CURB CHAIN (BRASS)

Article No.	Size (mm)	Size (Inch)	Thickness (mm)	Ring-ø (mm)	Box Qty.
C46-33	115	4-1/2	14	50	50
	125	5	14	50	50
	135	5-1/4	14	50	50

C46-43 German Silver



BAUCHER BIT MEDIUM PORT MOUTH WITH DOUBLE CURB CHAIN (STAINLESS STEEL)

Article No.	Size (mm)	Size (Inch)	Thickness (mm)	Ring-ø (mm)	Box Qty.
C46-56	115	4-1/2	14	50	50
	125	5	14	50	50
	135	5-1/4	14	50	50

BAUCHER BIT DOUBLE BROKEN LINK MOUTH (STAINLESS STEEL)

Article No.	Size (mm)	Size (Inch)	Thickness (mm)	Ring-ø (mm)	Box Qty.
C40-56	115	4-1/2	16	50	50
	125	5	16	50	50
	135	5-1/4	16	50	50



BAUCHER BIT DOUBLE BROKEN LINK MOUTH (GERMAN SILVER)

Article No.	Size (mm)	Size (Inch)	Thickness (mm)	Ring-ø (mm)	Box Qty.
C40-43	115	4-1/2	16	50	50
	125	5	16	50	50
	135	5-1/4	16	50	50

CRESCENDO BIT SNAFFLE COPPER MOUTH (STAINLESS STEEL)

Article No.	Size (mm)	Size (Inch)	Thickness (mm)	Ring-ø (mm)	Box Qty.
D51-29	125	5	12	40	70
	135	5-1/4	12	40	70



Quality creates demand

BAUCHER RING BITS

BAUCHER BIT SNAFFLE MOUTH (GERMAN SILVER)

Article No.	Size (mm)	Size (Inch)	Thickness (mm)	Ring-ø (mm)	Box Qty.
C41-43	115	4-1/2	12	30	80
C41-56	125	5	12	30	80
	135	5-1/4	12	30	80



BAUCHER BIT MULLEN CURVED MOUTH (STAINLESS STEEL)

Article No.	Size (mm)	Size (Inch)	Thickness (mm)	Ring-ø (mm)	Box Qty.
C55-56	115	4-1/2	12	50	80
	125	5	12	50	80
	135	5-1/4	12	50	80

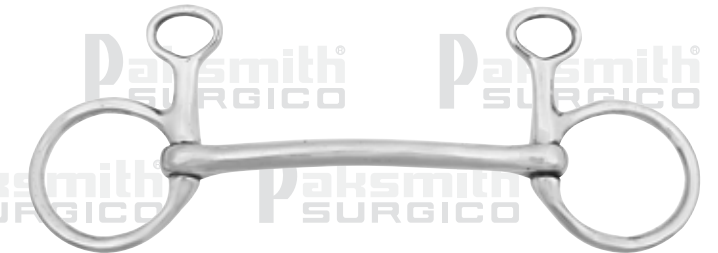

BAUCHER BIT MULLEN CURVED MOUTH (GERMAN SILVER)

Article No.	Size (mm)	Size (Inch)	Thickness (mm)	Ring-ø (mm)	Box Qty.
C55-43	115	4-1/2	12	50	80
	125	5	12	50	80
	135	5-1/4	12	50	80

BAUCHER BIT DOUBLE BROKEN LINK MOUTH (GERMAN SILVER)

Article No.	Size (mm)	Size (Inch)	Thickness (mm)	Ring-ø (mm)	Box Qty.
C48-43	115	4-1/2	14	50	80
	125	5	14	50	80
	135	5-1/4	14	50	80



BAUCHER BIT DOUBLE BROKEN GERMAN SILVER MOUTH (STAINLESS STEEL)

Article No.	Size (mm)	Size (Inch)	Thickness (mm)	Ring-ø (mm)	Box Qty.
C56-88	115	4-1/2	14	1-1/4	80
	125	5	14	1-1/4	80
	135	5-1/4	14	1-1/4	80



KIMBLE WICK BITS



KIMBLE WICK BIT, SS COPPER ROLLER MOUTH (STAINLESS STEEL)

Article No.	Size (mm)	Size (Inch)	Thickness (mm)	Ring-ø (Inch)	Box Qty.
D17-29	115	4-1/2	14	2-1/2	50
	125	5	14	2-1/2	50
	135	5-1/4	14	2-1/2	50
	120	4-1/2	14	2-1/2	50
	130	5	14	2-1/2	50
	140	5-1/2	14	2-1/2	50

KIMBLE WICK BIT, SNAFFLE MOUTH (STAINLESS STEEL)

Article No.	Size (mm)	Size (Inch)	Thickness (mm)	Ring-ø (Inch)	Box Qty.
D21-56	115	4-1/2	14	2-1/2	50
	125	5	14	2-1/2	50
	135	5-1/4	14	2-1/2	50

D21-33 Available in Complete Brass



KIMBLE WICK BIT, COPPER SNAFFLE MOUTH (STAINLESS STEEL)

Article No.	Size (mm)	Size (Inch)	Thickness (mm)	Ring-ø (Inch)	Box Qty.
D21-29	115	4-1/2	14	2-1/2	50
	125	5	14	2-1/2	50
	135	5-1/4	14	2-1/2	50

KIMBLE WICK BIT, SOLID MEDIUM PORT MOUTH (STAINLESS STEEL) Available in Brass / German Silver

Article No.	Size (mm)	Size (Inch)	Thickness (mm)	Ring-ø (Inch)	Box Qty.
D67-56	115	4-1/2	16	2-1/2	50
D67-33	125	5	16	2-1/2	50
D67-43	135	5-1/4	16	2-1/2	50

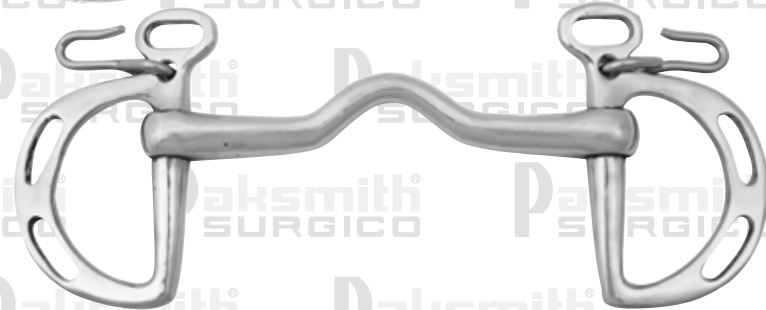

KIMBLE WICK BIT, TWICE BROKEN MOUTH (GERMAN SILVER)

Article No.	Size (mm)	Size (Inch)	Thickness (mm)	Ring-ø (Inch)	Box Qty.
D78-43	115	4-1/2	16	2-1/2	50
	125	5	16	2-1/2	50
	135	5-1/4	16	2-1/2	50

KIMBLE WICK BIT, SOLID MEDIUM PORT MOUTH (STAINLESS STEEL)

Article No.	Size (mm)	Size (Inch)	Thickness (mm)	Ring-ø (Inch)	Box Qty.
D125-56	115	4-1/2	16	2-1/2	50
	125	5	16	2-1/2	50
	135	5-1/4	16	2-1/2	50

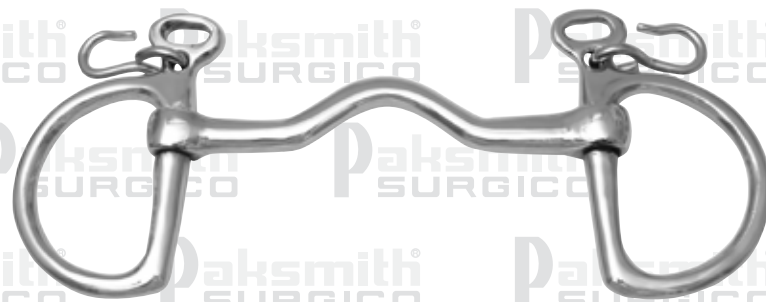

Curb Chain Sold Separately see page 147



MOUTH PIECE
Stainless Steel, German Silver, Copper, Brass, Sweet Iron with Copper In-lays

CHEEK
Stainless Steel, German Silver, CS/Nickel Plated

SIZES
Inches: 4", 4-1/4", 4-3/4", 5", 5-1/4", 5-1/2", 5-3/4", 6", 6-1/4", 6-1/2", 6-3/4", 7"cm:
9.50cm, 10.50cm, 11.50cm, 12.50cm, 13.50cm, 14.50cm, 15.50cm, 16.50cm, 17.50cm

DRIVING BITS

All Driving Bits are with Curb Chains

DRIVING BITS

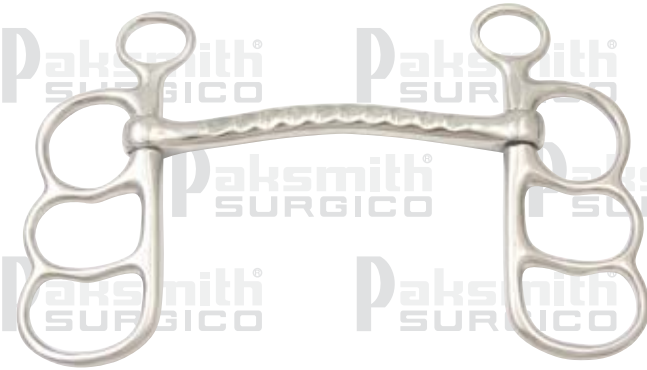

▶ BUTTERFLY 3-RING 16cm CHEEK, CURVED GROOVED MOUTH WITH DOUBLE CURB CHAIN (Stainless Steel)

Article No.	Size (mm)	Qualities Available	Thickness (mm)	Size (Inch)	Box Qty.
L01-56	115	56	16	4-1/2	40
	125	56	43	16	5
	135	56	16	5-1/4	40

◀ BUTTERFLY 3-RING 16cm CHEEK, CURVED GROOVED MOUTH WITH DOUBLE CURB CHAIN (German Silver)

Article No.	Size (mm)	Qualities Available	Thickness (mm)	Size (Inch)	Box Qty.
L61-43	115	43	16	4-1/2	40
	125	43	56	16	5
	135	43	16	5-1/4	40



▶ BUTTERFLY 2-RING 12cm CHEEK, CURVED GROOVED MOUTH WITH DOUBLE CURB CHAIN (Stainless Steel)

Article No.	Size (mm)	Qualities Available	Thickness (mm)	Size (Inch)	Box Qty.
L55-56	115	56	43	14	4-1/2
L55-43	125	56	43	14	5
	135	56	43	14	5-1/4
	145	56	43	14	5-3/4
	155	56	43	14	6

◀ BUTTERFLY 2-RING 13cm CHEEK, CURVED GROOVED MOUTH WITH DOUBLE CURB CHAIN (Stainless Steel)

Article No.	Size (mm)	Qualities Available	Thickness (mm)	Size (Inch)	Box Qty.
L05-56	115	56	16	4-1/2	50
	125	56	43	16	5
	135	56	16	5-1/4	50
	145	56	16	5-3/4	50



▶ BUTTERFLY 2-RINGS 13cm CHEEK, SNAFFLE MOUTH WITH SINGLE CURB CHAIN (Stainless Steel)

Article No.	Size (mm)	Qualities Available	Thickness (mm)	Size (Inch)	Box Qty.
L13-56	115	56	14	4-1/2	50
	125	56	88	14	5
	135	56	14	5-1/4	50

Everyone wants the best

DRIVING BITS



▶ BARCELONA BIT MULLEN MOUTH WITH DOUBLE CURB CHAIN (Stainless Steel)

Article No.	Size (mm)	Qualities Available	Thickness (mm)	Size (Inch)	Box Qty.
L20-56	105	56	13	4	50
	115	56	13	4-1/2	50
	125	56	13	5	50
	135	56	13	5-1/4	50

◀ BARCELONA BIT CURVED RIBBED MOUTH WITH DOUBLE CURB CHAIN (Stainless Steel)

Article No.	Size (mm)	Qualities Available	Thickness (mm)	Size (Inch)	Box Qty.
L67-56	115	56	14	4-1/2	50
	125	56	14	5	50
	135	56	14	5-1/4	50



▶ BARCELONA BIT LOW PORT MOUTH WITH DOUBLE CURB CHAIN (Stainless Steel)

Article No.	Size (mm)	Qualities Available	Thickness (mm)	Size (Inch)	Box Qty.
L21-56	105	56	18	4	40
	115	56	18	4-1/2	40
	125	56	18	5	40
	135	56	18	5-1/4	40

◀ PONY BARCELONA BIT CURVED RIBBED GERMAN SILVER MOUTH WITH DOUBLE CURB CHAIN (Stainless Steel)

Article No.	Size (mm)	Qualities Available	Thickness (mm)	Size (Inch)	Box Qty.
L84-88	115	88	12	4-1/2	50
	125	88	12	5	50

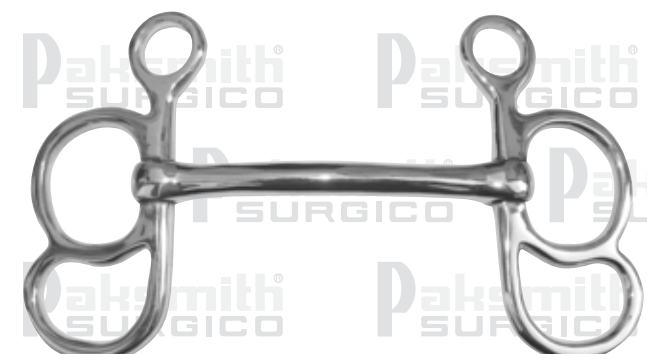

▶ BUTTERFLY 2-RING 13cm CHEEK, MULLEN MOUTH WITH DOUBLE CURB CHAIN (Stainless Steel)

Article No.	Size (mm)	Qualities Available	Thickness (mm)	Size (Inch)	Box Qty.
L65-56	115	56	14	4-1/2	50
	125	56	43	14	5
	135	56	14	5-1/4	50

DRIVING BITS



BUTTERFLY 2-RINGS 14cm CHEEK, CURVED SNAFFLE MOUTH WITH DOUBLE CURB CHAIN (Stainless Steel)

Article No.	Size (mm)	Qualities Available	Thickness (mm)	Size (Inch)	Box Qty.
L77-56	115	56	12	4-1/2	50
	125	56	12	5	50
	135	56	12	5-1/4	50
	145	56	12	5-3/4	50

BUTTERFLY 2-RINGS 14cm CHEEK, MULLEN MOUTH WITH DOUBLE CURB CHAIN (Stainless Steel)

Article No.	Size (mm)	Qualities Available	Thickness (mm)	Size (Inch)	Box Qty.	
L85-88	115	88	56	14	4-1/2	50
	125	88	14	5	50	
	135	88	14	5-1/4	50	



BUTTERFLY 3-RING 17cm CHEEK, COPPER MIDDLE LINK MOUTH WITH DOUBLE CURB CHAIN (Stainless Steel)

Article No.	Size (mm)	Qualities Available	Thickness (mm)	Size (Inch)	Box Qty.
L32-29	150	56	14	6	40
	165	56	14	6-1/2	40
	178	56	14	7	40

LIVERPOOL MEDIUM PORT GERMAN SILVER MOUTH WITH DOUBLE CURB CHAIN (Stainless Steel)

Article No.	Size (mm)	Qualities Available	Thickness (mm)	Size (Inch)	Box Qty.
L70-88	115	88	14	4-1/2	60
	125	88	14	5	60
	135	88	14	5-1/4	60



LIVERPOOL 2-SLOTS, CURVED RIBBED GERMAN SILVER MOUTH WITH DOUBLE CURB CHAIN (Stainless Steel)

Article No.	Size (mm)	Qualities Available	Thickness (mm)	Size (Inch)	Box Qty.
L58-88	115	88	16	4-1/2	50
	125	88	16	5	50
	135	88	16	5-1/4	50

Everyone wants the best

DRIVING BITS



WEYMOUTH 13cm CHEEK FORWARD DOUBLE BROKEN GERMAN SILVER MOUTH WITH DOUBLE CURB CHAIN (Stainless Steel)

Article No.	Size (mm)	Qualities Available	Thickness (mm)	Lower Cheek (cm)	Size (Inch)	Box Qty.	
L87-88	115	88	56	14	7	4-1/2	60
	125	88	14	7	5	60	
	135	88	14	7	5-1/4	60	

WEYMOUTH 13cm CHEEK MULLEN MOUTH WITH DOUBLE CURB CHAIN (Stainless Steel)

Article No.	Size (mm)	Qualities Available	Thickness (mm)	Lower Cheek (cm)	Size (Inch)	Box Qty.
L88-56	115	56	14	7	4-1/2	60
	125	56	14	7	5	60
	135	56	14	7	5-1/4	60



WEYMOUTH 13cm CHEEK DOUBLE BROKEN GERMAN SILVER MOUTH WITH DOUBLE CURB CHAIN (Stainless Steel)

Article No.	Size (mm)	Qualities Available	Thickness (mm)	Lower Cheek (cm)	Size (Inch)	Box Qty.
L89-88	115	88	12	7	4-1/2	50
	125	88	12	7	5	50
	135	88	12	7	5-1/4	50

LIVERPOOL 3-SLOTS, CURVED MULLEN MOUTH WITH DOUBLE CURB CHAIN (Stainless Steel)

Article No.	Size (mm)	Qualities Available	Thickness (mm)	Size (Inch)	Box Qty.
L90-56	115	56	16	4-1/2	40
	125	56	16	5	40
	135	56	16	5-1/4	40



LIVERPOOL 3-SLOTS DOUBLE BROKEN COPPER NUT GERMAN SILVER MOUTH WITH CHAIN (Stainless Steel)

Article No.	Size (mm)	Qualities Available	Thickness (mm)	Size (Inch)	Box Qty.
L91-88	115	88	14	4-1/2	40
	125	88	14	5	40
	135	88	14	5-1/4	40

WEYMOUTH BITS



WEYMOUTH 13cm CHEEK LOW PORT HOLLOW MOUTH WITH DOUBLE CURB CHAIN (Stainless Steel)

Article No.	Size (mm)	Qualities Available	Thickness (mm)	Lower Cheek (cm)	Size (Inch)	Box Qty.
L27-03	115	56	22	7	4-1/2	50
	125	56	22	7	5	50
	135	56	22	7	5-1/4	50

WEYMOUTH 13cm CHEEK LOW PORT MOUTH WITH DOUBLE CURB CHAIN (Stainless Steel)

Article No.	Size (mm)	Qualities Available	Thickness (mm)	Lower Cheek (cm)	Size (Inch)	Box Qty.
L15-56	125	56	12	7	5	50
	135	56	12	7	5-1/4	50



WEYMOUTH 13cm CHEEK MULLEN MOUTH WITH DOUBLE CURB CHAIN (Stainless Steel)

Article No.	Size (mm)	Qualities Available	Thickness (mm)	Lower Cheek (cm)	Size (Inch)	Box Qty.
L11-56	115	56	14	7	4-1/2	50
	125	56	14	7	5	50
	135	56	14	7	5-1/4	50



WEYMOUTH 13cm CHEEK MULLEN MOUTH WITH DOUBLE CURB CHAIN (Stainless Steel)

Article No.	Size (mm)	Qualities Available	Thickness (mm)	Lower Cheek (cm)	Size (Inch)	Box Qty.
L16-56	115	56	12	7	4-1/2	50
	125	56	12	7	5	50
	135	56	12	7	5-1/4	50



WEYMOUTH 13cm CHEEK MEDIUM PORT GERMAN SILVER MOUTH WITH DOUBLE CURB CHAIN (Stainless Steel)

Article No.	Size (mm)	Qualities Available	Thickness (mm)	Lower Cheek (cm)	Size (Inch)	Box Qty.
L68-88	115	88	14	7	4-1/2	50
	125	88	14	7	5	50
	135	88	14	7	5-1/4	50



WEYMOUTH 12cm CHEEK SLIDING MOUTH WITH DOUBLE CURB CHAIN (Stainless Steel)

Article No.	Size (mm)	Qualities Available	Thickness (mm)	Lower Cheek (cm)	Size (Inch)	Box Qty.	
L42-56	105	56	14	7	9	4	60
L43-56	115	56	14	7	9	4-1/2	60
	125	56	14	7	9	5	60
	135	56	14	7	9	5-1/4	60



WEYMOUTH 14cm CHEEK SLIDING MOUTH WITH DOUBLE CURB CHAIN (Stainless Steel)

Article No.	Size (mm)	Qualities Available	Thickness (mm)	Lower Cheek (cm)	Size (Inch)	Box Qty.
L79-56	115	56	14	7	4-1/2	60
	125	56	14	7	5	60
	135	56	14	7	5-1/4	60



WEYMOUTH 12cm CHEEK SLIDING MOUTH WITH DOUBLE CURB CHAIN (Stainless Steel)

Article No.	Size (mm)	Qualities Available	Thickness (mm)	Lower Cheek (cm)	Size (Inch)	Box Qty.
L17-56	115	56	12	7	4-1/2	50
	125	56	12	7	5	50
	135	56	12	7	5-1/4	50

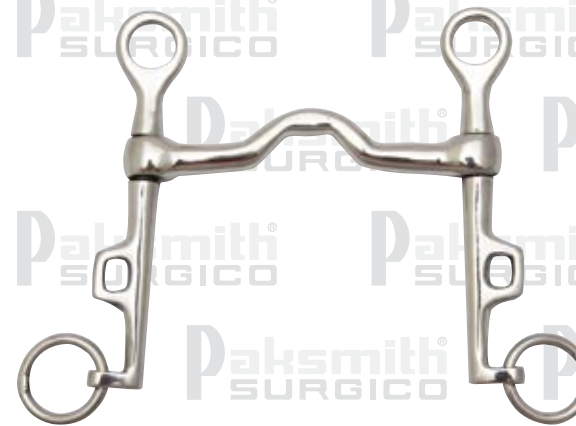

WEYMOUTH 13cm CHEEK LOW PORT MOUTH WITH DOUBLE CURB CHAIN (Stainless Steel)

Article No.	Size (mm)	Qualities Available	Thickness (mm)	Lower Cheek (cm)	Size (Inch)	Box Qty.
L56-56	115	56	14	7	4-1/2	50
	125	56	14	7	5	50
	135	56	14	7	5-1/4	50



WEYMOUTH FORWARD PORT WARBLOOD GERMAN SILVER MOUTH WITH DOUBLE CURB CHAIN (Stainless Steel)

Article No.	Size (mm)	Qualities Available	Thickness (mm)	Lower Cheek (cm)	Size (Inch)	Box Qty.		
L36-88	115	88	16	5	7	9	4-1/2	50
	125	88	16	5	7	9	5	50
	135	88	16	5	7	9	5-1/4	50



LIVERPOOL BITS



LIVERPOOL 3-SLOTS, CURVED RIBBED MOUTH WITH DOUBLE CURB CHAIN (Stainless Steel)

Article No.	Size (mm)	Qualities Available	Thickness (mm)	Size (Inch)	Box Qty.
L02-56	115	56	16	4-1/2	40
	125	56	16	5	40
	135	56	16	5-1/4	40

LIVERPOOL 3-SLOTS, MULLEN MOUTH WITH DOUBLE CURB CHAIN (Stainless Steel)

Article No.	Size (mm)	Qualities Available	Thickness (mm)	Size (Inch)	Box Qty.
L07-56	115	56	16	4-1/2	40
	125	56	88	5	40
	135	56	16	5-1/4	40



LIVERPOOL 3-SLOTS, CURVED RIBBED GERMAN SILVER MOUTH WITH DOUBLE CURB CHAIN (Stainless Steel)

Article No.	Size (mm)	Qualities Available	Thickness (mm)	Size (Inch)	Box Qty.
L02-88	115	88	16	4-1/2	40
	125	88	16	5	40
	135	88	16	5-1/4	40



LIVERPOOL 3-SLOTS, STRAIGHT RIBBED MOUTH WITH DOUBLE CURB CHAIN (Stainless Steel)

Article No.	Size (mm)	Qualities Available	Thickness (mm)	Size (Inch)	Box Qty.
L26-56	115	56	16	4-1/2	40
	125	56	16	5	40
	135	56	16	5-1/4	40



LIVERPOOL 2-SLOTS, STRAIGHT RIBBED MOUTH WITH DOUBLE CURB CHAIN (German Silver)

Article No.	Size (mm)	Qualities Available	Thickness (mm)	Size (Inch)	Box Qty.
L04-43	105	43	56	12	4
L04-56	115	43	12	4-1/2	50
	125	43	12	5	50
	135	43	12	5-1/4	50



Everyone wants the best

LIVERPOOL BITS



FIX LIVERPOOL 3-SLOTS CURVED MOUTH WITH SINGLE CURB CHAIN (Stainless Steel)

Article No.	Size (mm)	Qualities Available	Thickness (mm)	Size (Inch)	Box Qty.
L41-56	115	56	15	4-1/2	32
	125	56	15	5	32
	135	56	15	5-1/4	32
	145	56	15	5-3/4	32

FIX LIVERPOOL 3-SLOTS CURVED MOUTH WITH SINGLE CURB CHAIN (Stainless Steel)

Article No.	Size (mm)	Qualities Available	Thickness (mm)	Size (Inch)	Box Qty.
L30-56	115	56	15	4-1/2	32
	125	56	15	5	32
	135	56	15	5-1/4	32
	145	56	15	5-3/4	32
	160	56	15	6-1/4	32

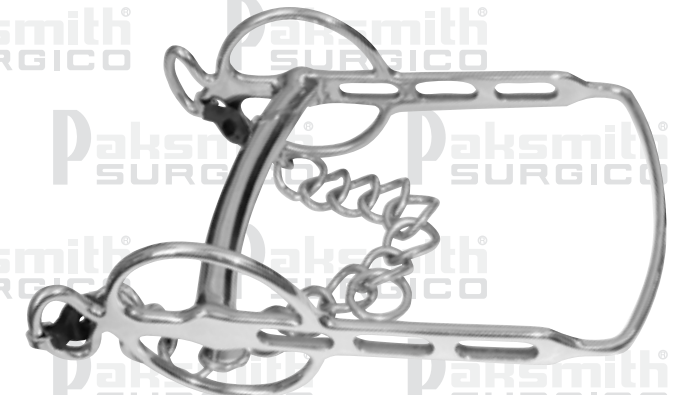

FIX LIVERPOOL 3-SLOTS STRAIGHT RIBBED MOUTH WITH SINGLE CURB CHAIN (Stainless Steel)

Article No.	Size (mm)	Qualities Available	Thickness (mm)	Size (Inch)	Box Qty.
L45-56	115	56	16	4-1/2	32
	125	56	16	5	32
	135	56	16	5-1/4	32



FIX LIVERPOOL 3-SLOTS LOW PORT COPPER ROLLER MOUTH WITH DOUBLE CURB CHAIN (Stainless Steel)

Article No.	Size (mm)	Qualities Available	Thickness (mm)	Size (Inch)	Box Qty.
L83-29	115	29	15	4-1/2	32
	125	29	15	5	32
	135	29	15	5-1/4	32
	145	29	15	5-3/4	32



FIX LIVERPOOL 3-SLOTS CURVED RUBBER MOUTH WITH DOUBLE CURB CHAIN (Stainless Steel)

Article No.	Size (mm)	Qualities Available	Thickness (mm)	Size (Inch)	Box Qty.
L100	115	56	18	4-1/2	32
	125	56	18	5	32
	135	56	18	5-1/4	32



LIVERPOOL BITS

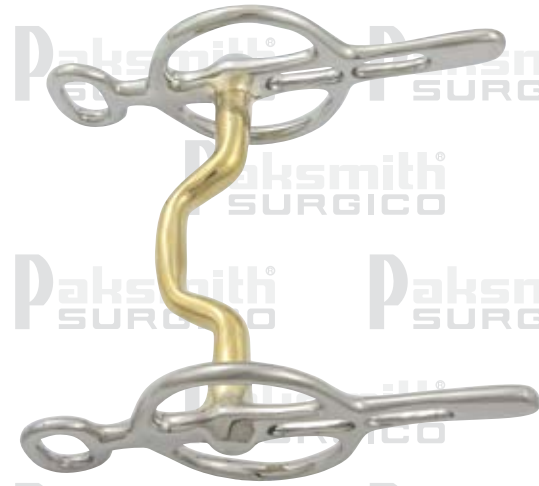

FIX LIVERPOOL 2-SLOTS FORWARD PORT GERMAN SILVER MOUTH WITH DOUBLE CURB CHAIN (Stainless Steel)

Article No.	Size (mm)	Qualities Available	Thickness (mm)	Size (Inch)	Box Qty.
L46-88	115	88	15	4-1/2	40
	125	88	15	5	40
	135	88	15	5-1/4	40

FIX LIVERPOOL 3-SLOTS CURVED MOUTH WITH DOUBLE CURB CHAIN (Stainless Steel)

Article No.	Size (mm)	Qualities Available	Thickness (mm)	Size (Inch)	Box Qty.
L63-56	115	56	15	4-1/2	32
	125	56	15	5	32
	135	56	15	5-1/4	32

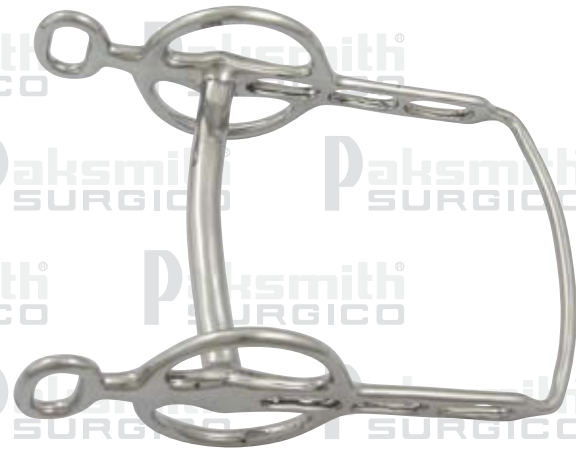

DRIVING BIT STRAIGHT MULLEN MOUTH WITH DOUBLE CURB CHAIN (German Silver)

Article No.	Size (mm)	Qualities Available	Thickness (mm)	Size (Inch)	Box Qty.
L47-43	125	43	16	5	50
	135	43	16	5-1/4	50



LIVERPOOL 2-SLOTS, RIBBED MOUTH WITH DOUBLE CURB CHAIN (German Silver)

Article No.	Size (mm)	Qualities Available	Thickness (mm)	Size (Inch)	Box Qty.
L48-43	125	43	16	5	50
	135	43	16	5-1/4	50



LIVERPOOL 3-SLOTS, FORWARD PORT GERMAN SILVER MOUTH WITH DOUBLE CURB CHAIN (German Silver)

Article No.	Size (mm)	Qualities Available	Thickness (mm)	Size (Inch)	Box Qty.
L62-88	125	88	16	5	40
	135	88	16	5-1/4	40



LIVERPOOL BITS

Everyone wants the best



LIVERPOOL 3 SLOTS HIGH PORT MOUTH 2 EXTRA RINGS WITH DOUBLE CURB CHAIN (Stainless Steel)

Article No.	Size (mm)	Qualities Available	Thickness (mm)	Size (Inch)	Box Qty.
L71-56	115	56	14	4-1/2	40
	125	56	14	5	40
	135	56	14	5-1/4	40



LIVERPOOL 2 SLOTS MIDDLE LINK MOUTH WITH DOUBLE CURB CHAIN (Stainless Steel)

Article No.	Size (mm)	Qualities Available	Thickness (mm)	Size (Inch)	Box Qty.
L72-56	115	56	17	4-1/2	40
	125	56	17	5	40
	135	56	17	5-1/4	40



LIVERPOOL 2 SLOTS MIDDLE LINK MOUTH WITH DOUBLE CURB CHAIN (Stainless Steel)

Article No.	Size (mm)	Qualities Available	Thickness (mm)	Size (Inch)	Box Qty.
L73-56	115	56	17	4-1/2	40
	125	56	17	5	40
	135	56	17	5-1/4	40



LIVERPOOL 2 SLOTS 16cm FLAT REVOLVING MOUTH WITH DOUBLE CURB CHAIN (Stainless Steel)

Article No.	Size (mm)	Qualities Available	Width (mm)	Size (Inch)	Box Qty.
L60-56	115	56	32	4-1/2	40
	125	56	32	5	40
	135	56	32	5-1/4	40



LIVERPOOL BITS



DRIVING BIT 17,50cm CHEEK, SWEET IRON MOUTH WITH DOUBLE CURB CHAIN (Stainless Steel)

Article No.	Size (mm)	Qualities Available	Thickness (mm)	Size (Inch)	Box Qty.
L34-39	125	39	10	5	34
	152	39	10	6	34
	165	39	10	6-1/2	34

DRIVING BIT 17,50cm CHEEK, SWEET IRON FORWARD COPPER LINE MOUTH WITH DOUBLE CURB CHAIN (SS)

Article No.	Size (mm)	Qualities Available	Thickness (mm)	Size (Inch)	Box Qty.
L33-39	125	39	10	5	34
	152	39	10	6	34
	165	39	10	6-1/2	34



CLASSIC CHEEK BIT DOUBLE BROKEN MOUTH (German Silver)

Article No.	Size (mm)	Qualities Available	Thickness (mm)	Size (Inch)	Box Qty.	
L82-56	115	56	43	14	4-1/2	60
	125	56	14	5	60	
	135	56	14	5-1/4	60	

CLASSIC CHEEK BIT LOW PORT MOUTH (German Silver)

Article No.	Size (mm)	Qualities Available	Thickness (mm)	Size (Inch)	Box Qty.
L81-56	115	56	14	4-1/2	60
	125	56	14	5	60
	135	56	14	5-1/4	60



CLASSIC CHEEK BIT SNAFFLE MOUTH (German Silver)

Article No.	Size (mm)	Qualities Available	Thickness (mm)	Size (Inch)	Box Qty.
L80-43	115	43	12	4-1/2	60
	125	43	12	5	60
	135	43	12	5-1/4	60

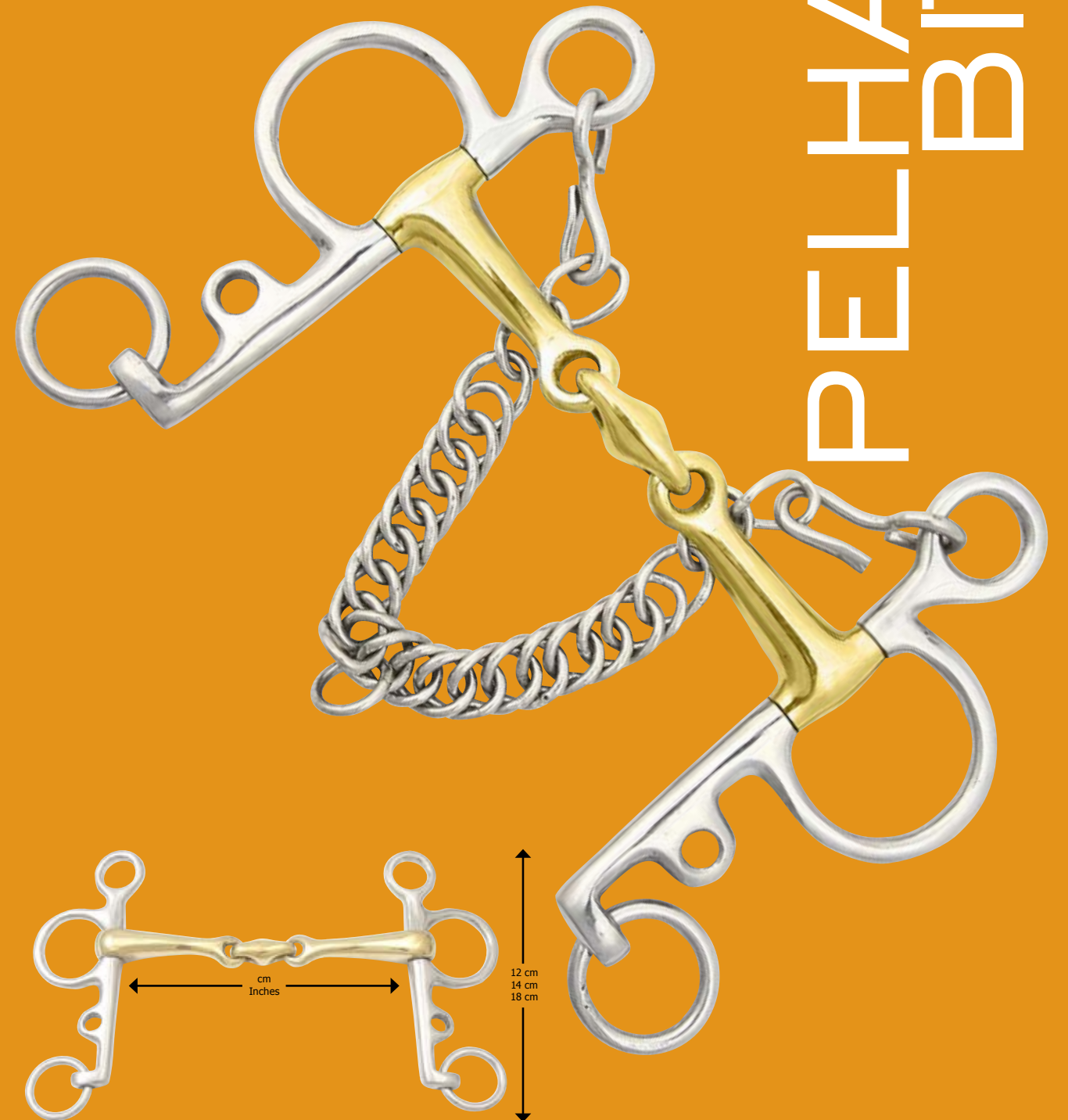

PELHAM BITS

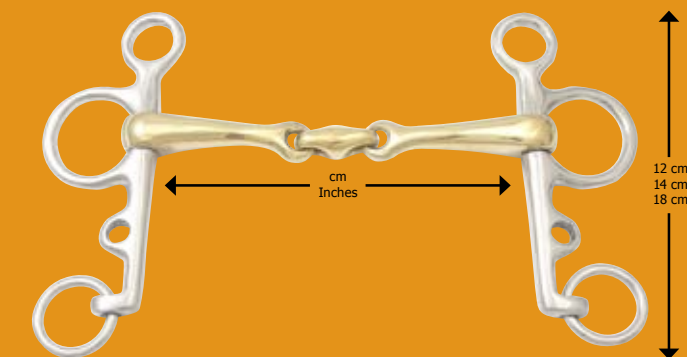

MOUTH PIECE
Stainless Steel, German Silver, Copper Roller, Brass

CHEEK
Stainless Steel, Brass, German Silver, CS/Nickel Plated

SIZES
Inches: 4", 4-1/4", 4-3/4", 5", 5-1/4", 5-1/2", 5-3/4", 6", 6-1/4", 6-1/2", 6-3/4", 7"

cm: 9.50cm, 10.50cm, 11.50cm, 12.50cm, 13.50cm, 14.50cm, 15.50cm, 16.50cm, 17.50cm

All Pelham Bits are with Curb Chains

PELHAM BITS

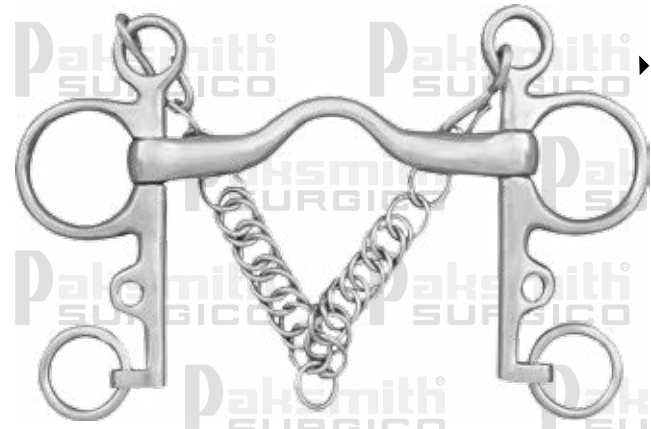

PELHAM 14cm CHEEK MEDIUM PORT MOUTH WITH DOUBLE CURB CHAIN (Stainless Steel)

Article No.	Size (mm)	Qualities Available	Thickness (mm)	Lower Cheek (cm)	Size (Inch)	Box Qty.
L14	115	56	16	7	4-1/2	40
	125	56 88	16	7	5	40
	135	56	16	7	5-1/4	40

PELHAM 14cm SNAFFLE HOLLOW MOUTH WITH DOUBLE CURB CHAIN (Stainless Steel)

Article No.	Size (mm)	Qualities Available	Thickness (mm)	Lower Cheek (cm)	Size (Inch)	Box Qty.
L66-03	115	56	18	7	4-1/2	40
	125	56	18	7	5	40
	135	56	18	7	5-1/4	40

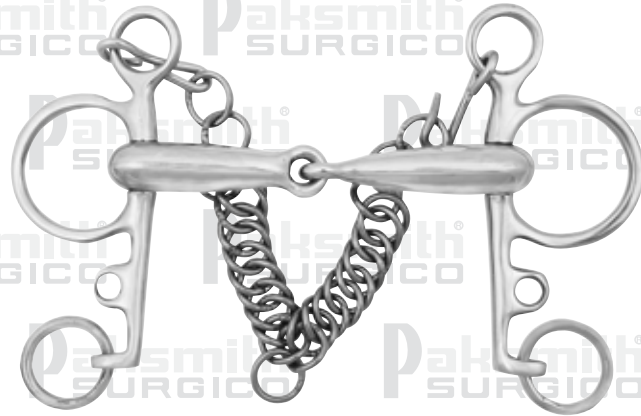

PELHAM 14cm SNAFFLE MOUTH WITH DOUBLE CURB CHAIN (Stainless Steel)

Article No.	Size (mm)	Qualities Available	Thickness (mm)	Lower Cheek (cm)	Size (Inch)	Box Qty.
L06	115	56	16	7	4-1/2	40
	125	56 88	16	7	5	40
	135	56	16	7	5-1/4	40

PELHAM 45mm RING, CURVED MULLEN MOUTH WITH DOUBLE CURB CHAIN (Stainless Steel)

Article No.	Size (mm)	Qualities Available	Thickness (mm)	Lower Cheek (cm)	Size (Inch)	Box Qty.
L12	115	56	14	7	4-1/2	40
	125	56 88	14	7	5	40
	135	56	14	7	5-1/4	40

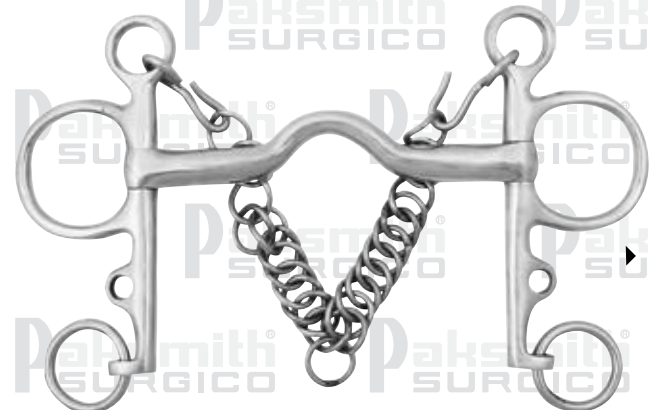
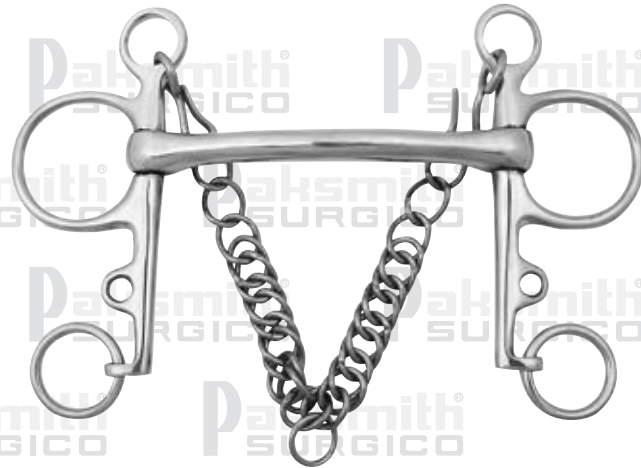

14cm PELHAM BIT 45mm RING, MEDIUM PORT PINCH-LESS MOUTH WITH DOUBLE CURB CHAIN (Stainless Steel)

Article No.	Size (mm)	Qualities Available	Thickness (mm)	Lower Cheek (cm)	Size (Inch)	Box Qty.
L50	115	56	15	7	4-1/2	40
	125	56 88	15	7	5	40
	135	56	15	7	5-1/4	40

You never got so much for so little

PELHAM BITS



PELHAM 14cm CHEEK DOUBLE BROKEN GERMAN SILVER MOUTH WITH DOUBLE CURB CHAIN (Stainless Steel)

Article No.	Size (mm)	Qualities Available	Thickness (mm)	Lower Cheek (cm)	Size (Inch)	Box Qty.
L52-88	115	88	16	7	4-1/2	50
	125	88 56	16	7	5	50
	135	88	16	7	5-1/4	50

PELHAM 14cm CHEEK DOUBLE BROKEN MOUTH WITH DOUBLE CURB CHAIN (German Silver)

Article No.	Size (mm)	Qualities Available	Thickness (mm)	Lower Cheek (cm)	Size (Inch)	Box Qty.
L52-43	115	43	16	7	4-1/2	50
	125	43	16	7	5	50
	135	43	16	7	5-1/4	50



PELHAM 14cm CHEEK FORWARD PORT GERMAN SILVER MOUTH WITH DOUBLE CURB CHAIN (Stainless Steel)

Article No.	Size (mm)	Qualities Available	Thickness (mm)	Lower Cheek (cm)	Size (Inch)	Box Qty.
L35-88	115	88	16	7	4-1/2	50
	125	88 56	16	7	5	50
	135	88	16	7	5-1/4	50

PELHAM 14cm CHEEK DOUBLE BROKEN GERMAN SILVER MOUTH WITH DOUBLE CURB CHAIN (Stainless Steel)

Article No.	Size (mm)	Qualities Available	Thickness (mm)	Lower Cheek (cm)	Size (Inch)	Box Qty.
L64-88	115	88	16	7	4-1/2	50
	125	88 56	16	7	5	50
	135	88	16	7	5-1/4	50



PELHAM 14cm CHEEK RIBBED CURVED MOUTH WITH DOUBLE CURB CHAIN (Stainless Steel)

Article No.	Size (mm)	Qualities Available	Thickness (mm)	Lower Cheek (cm)	Size (Inch)	Box Qty.
L54-56	115	56	16	7	4-1/2	50
	125	56	16	7	5	50
	135	56	16	7	5-1/4	50



PELHAM BITS



PELHAM 14cm CHEEK CURVED RIGID RUBBER MOUTH WITH DOUBLE CURB CHAIN (Stainless Steel)

Article No.	Size (mm)	Qualities Available	Thickness (mm)	Lower Cheek (cm)	Size (Inch)	Box Qty.
L03-56	115	56	20	7	4-1/2	40
	125	56	20	7	5	40
	135	56	20	7	5-1/4	40
L22-56	140	STRAIGHT RIGID Mouth		7	5-1/2	40

PELHAM 14cm CHEEK SNAFFLE RUBBER MOUTH WITH DOUBLE CURB CHAIN (Stainless Steel)

Article No.	Size (mm)	Qualities Available	Thickness (mm)	Lower Cheek (cm)	Size (Inch)	Box Qty.
L08-56	115	56	20	7	4-1/2	40
	125	56	20	7	5	40
	135	56	20	7	5-1/4	40



PELHAM 18cm CHEEK MEDIUM PORT RUBBER MOUTH WITH DOUBLE CURB CHAIN (Stainless Steel)

Article No.	Size (mm)	Qualities Available	Thickness (mm)	Lower Cheek (cm)	Size (Inch)	Box Qty.
L23-56	115	56	20	13	4-1/2	40
	125	56	20	13	5	40
	135	56	20	13	5-1/4	40

PELHAM 14cm CHEEK MEDIUM PORT RUBBER MOUTH WITH DOUBLE CURB CHAIN (Stainless Steel)

Article No.	Size (mm)	Qualities Available	Thickness (mm)	Lower Cheek (cm)	Size (Inch)	Box Qty.
L29-56	115	56	20	7	4-1/2	40
	125	56	20	7	5	40
	135	56	20	7	5-1/4	40



PELHAM 14cm CHEEK FLEXIBLE RUBBER MOUTH WITH DOUBLE CURB CHAIN (Stainless Steel)

Article No.	Size (mm)	Qualities Available	Thickness (mm)	Lower Cheek (cm)	Size (Inch)	Box Qty.
L09-56	115	56	20	7	4-1/2	40
	125	56	20	7	5	40
	135	56	20	7	5-1/4	40



You never got so much for so little

PELHAM BITS

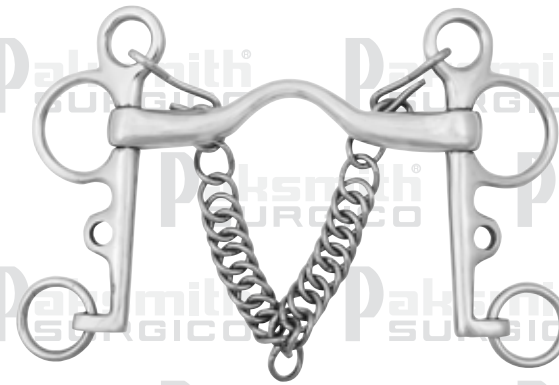

PELHAM 14cm SMALL RING CHEEK MEDIUM PORT MOUTH WITH DOUBLE CURB CHAIN (Stainless Steel)

Article No.	Size (mm)	Qualities Available	Thickness (mm)	Lower Cheek (cm)	Size (Inch)	Box Qty.
L24	115	56	16	7	4-1/2	40
	125	56	16	7	5	40
	135	56	16	7	5-1/4	40
	140	56	16	7	5-1/2	40

PELHAM 14cm SMALL RING CHEEK SNAFFLE MOUTH WITH DOUBLE CURB CHAIN (Stainless Steel)

Article No.	Size (mm)	Qualities Available	Thickness (mm)	Lower Cheek (cm)	Size (Inch)	Box Qty.
L76	115	56	14	7	4-1/2	50
	125	56	14	7	5	50
	135	56	14	7	5-1/4	50
	140	56	14	7	5-1/2	50

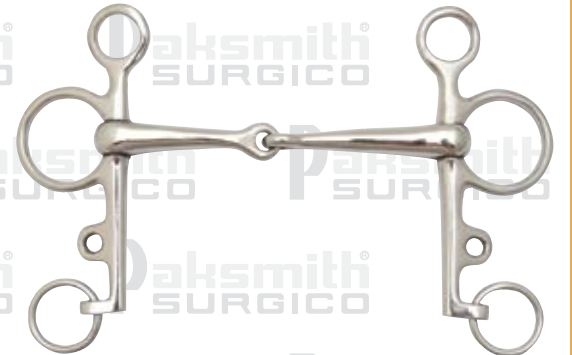

PELHAM 14cm SMALL RING CHEEK LOW PORT MOUTH WITH DOUBLE CURB CHAIN (Stainless Steel)

Article No.	Size (mm)	Qualities Available	Thickness (mm)	Lower Cheek (cm)	Size (Inch)	Box Qty.
L75	115	56	16	7	4-1/2	40
	125	56	16	7	5	40
	135	56	16	7	5-1/4	40
	140	56	16	7	5-1/2	40

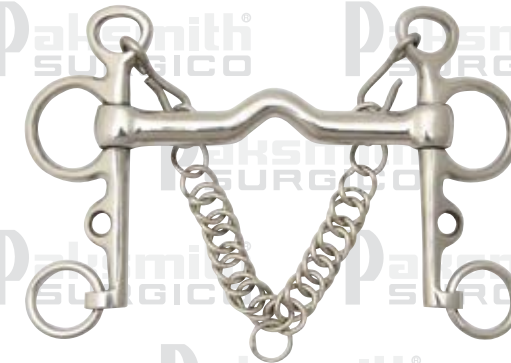

PELHAM 14cm CHEEK, MEDIUM PORT MOUTH WITH DOUBLE CURB CHAIN (Stainless Steel)

Article No.	Size (mm)	Qualities Available	Thickness (mm)	Size (Inch)	Box Qty.
L59	115	56	14	4-1/2	50
	125	56	14	5	50
	135	56	14	5-1/4	50



PELHAM 14cm CHEEK SNAFFLE GERMAN SILVER MOUTH WITH DOUBLE CURB CHAIN (Stainless Steel)

Article No.	Size (mm)	Qualities Available	Thickness (mm)	Lower Cheek (cm)	Size (Inch)	Box Qty.
L90	115	88	13	7	4-1/2	40
	125	88	13	7	5	40
	135	88	13	7	5-1/4	40





MARATHON SNAP HOOK
(Stainless Steel)

Article No.	Wide (mm)	Box Qty.
K23-30	30	150



MARATHON SNAP HOOK
with **screw** (Stainless Steel)

Article No.	Wide (mm)	Box Qty.
K35-30	30	60



MARATHON SNAP HOOK
(Stainless Steel)

Article No.	Wide (mm)	Box Qty.
K23-15	15	150
K23-25	25	70



MARATHON SNAP HOOK
(Stainless Steel)

Article No.	Wide (mm)	Box Qty.
K23-40	40	60



MARATHON SNAP HOOK
with D-Ring (SS)

Article No.	Wide (mm)	Box Qty.
K23-35	35	110



MARATHON SNAP HOOK
(Stainless Steel)

Article No.	Wide (mm)	Box Qty.
K51-25	25	60



MARATHON SNAP HOOK
with Buckle (Stainless Steel)

Article No.	Wide (mm)	Box Qty.
K34-40	40	50



MARATHON SNAP HOOK
Buckle with Leather (SS)

Article No.	Wide (mm)	Box Qty.
K36-40	40	25

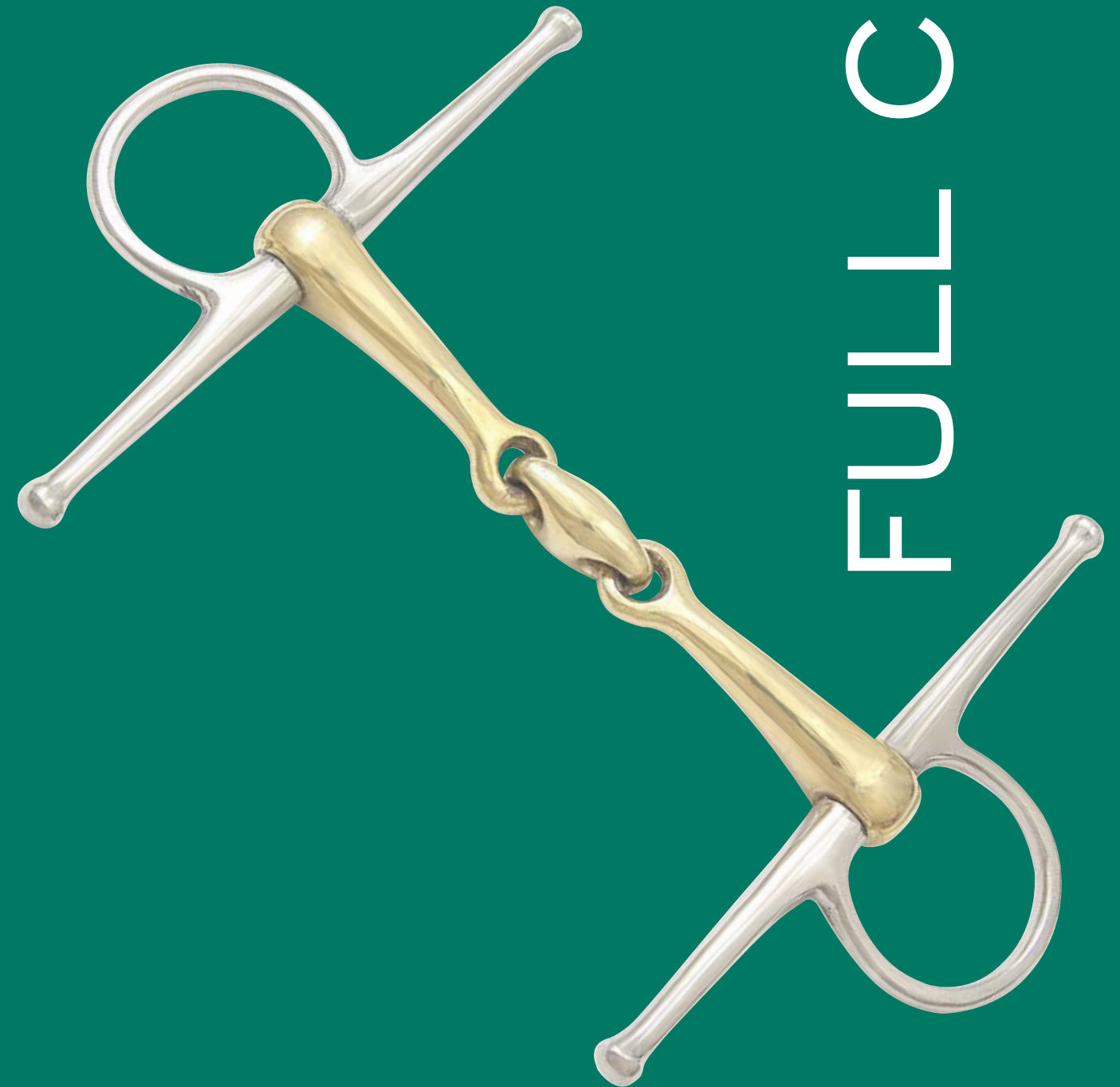

STEELE
CHECK
BITS
FULL
TURN

FULL CHEEK BITS

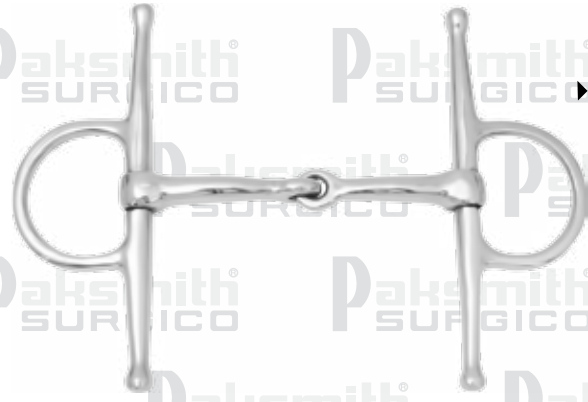

FULL CHEEK SNAFFLE MOUTH (STAINLESS STEEL)

Article No.	Mouth Material	Size (mm)	Size (Inch)	Thickness (mm)	Cheek (Inch)	Box Qty.
F05-56	SS	115	4-1/2	12	6	60
F05-29	Copper	125	5	12	6	60
		135	5-1/4	12	6	60

FULL CHEEK SNAFFLE RUBBER MOUTH (STAINLESS STEEL)

Article No.	Size (mm)	Size (Inch)	Thickness (mm)	Cheek (Inch)	Box Qty.
F18-56	115	4-1/2	20	6	60
	125	5	20	6	60
	135	5-1/4	20	6	60

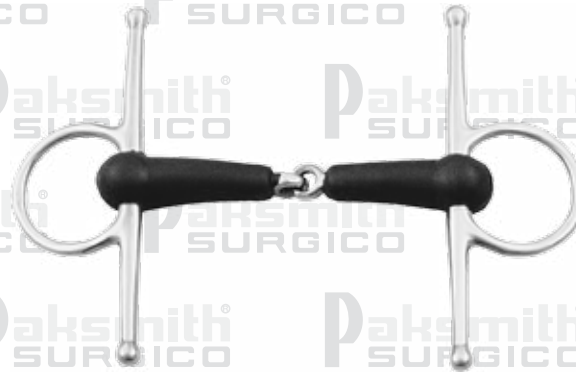

FULL CHEEK DOUBLE TWISTED COPPER MOUTH (STAINLESS STEEL)

Article No.	Mouth Material	Size (mm)	Size (Inch)	Thickness (mm)	Cheek (Inch)	Box Qty.
F21-29	Copper	115	4-1/2	14	6	60
F21-39	SW/Iron	125	5	14	6	60
		135	5-1/4	14	6	60

FULL CHEEK BIT DOG BONE LINK MOUTH (STAINLESS STEEL)

Article No.	Size (mm)	Size (Inch)	Thickness (mm)	Cheek (Inch)	Box Qty.
F25-56	115	4-1/2	14	6	60
	125	5	14	6	60
	135	5-1/4	14	6	60

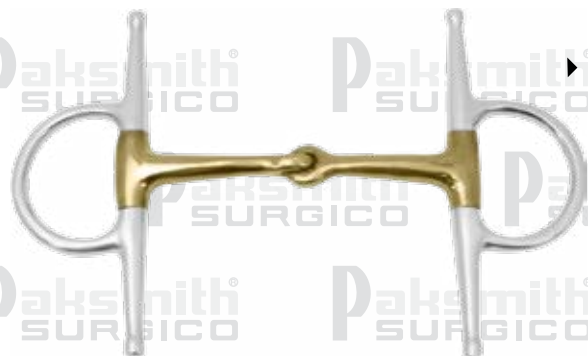
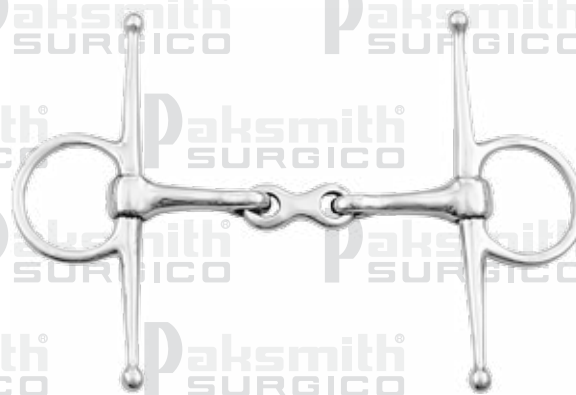

FULL CHEEK SNAFFLE COPPER MOUTH (STAINLESS STEEL)

Article No.	Mouth Material	Size (mm)	Size (Inch)	Thickness (mm)	Cheek (Inch)	Box Qty.
F06-29	Copper	115	4-1/2	14	6	60
F06-56	SS	125	5	14	6	60
		135	5-1/4	14	6	60

Everyone wants the best

FULL CHEEK BITS



FULL CHEEK DOUBLE BROKEN LINK GERMAN SILVER MOUTH (STAINLESS STEEL)

Article No.	Size (mm)	Size (Inch)	Thickness (mm)	Cheek (Inch)	Box Qty.
F26-88	115	4-1/2	16	6	60
	125	5	16	6	60
	135	5-1/4	16	6	60

FULL CHEEK BIT QUARTER MOON MOUTH (STAINLESS STEEL)

Article No.	Mouth Material	Size (mm)	Size (Inch)	Thickness (mm)	Cheek (Inch)	Box Qty.
F15-56	SS	115	4-1/2	14	6	60
F15-29	Copper Link	125	5	14	6	60
		135	5-1/4	14	6	60



FULL CHEEK BIT QUARTER MOON MOUTH (GERMAN SILVER)

Article No.	Mouth Material	Size (mm)	Size (Inch)	Thickness (mm)	Cheek (Inch)	Box Qty.
F37-43	German Silver	115	4-1/2	14	6	60
		125	5	14	6	60
		135	5-1/4	14	6	60

PONY FULL CHEEK SNAFFLE PINCH-LESS MOUTH (STAINLESS STEEL)

Article No.	Size (mm)	Size (Inch)	Thickness (mm)	Cheek (cm)	Box Qty.
F28-56	115	4-1/2	14	12	80
	125	5	14	12	80
	135	5-1/4	14	12	80



FULL CHEEK SNAFFLE PINCH-LESS MOUTH (STAINLESS STEEL)

Article No.	Size (mm)	Size (Inch)	Thickness (mm)	Cheek (Inch)	Box Qty.
F40-56	115	4-1/2	16	6	80
	125	5	16	6	80
	135	5-1/4	16	6	80

www.paksmith.com

www.paksmith.com

FULL CHEEK BITS



FULL CHEEK SNAFFLE HOLLOW MOUTH (STAINLESS STEEL)

Article No.	Size (mm)	Size (Inch)	Thickness (mm)	Cheek (Inch)	Box Qty.
F31-03	115	4-1/2	20	6	70
	125	5	20	6	70
	135	5-1/4	20	6	70

FULL BUSHING CHEEK FORWARD SS ROLLER COPPER INLAY MOUTH (STAINLESS STEEL)

Article No.	Size (mm)	Size (Inch)	Thickness (mm)	Cheek (Inch)	Box Qty.
F29-56	115	4-1/2	12	6	60
	125	5	12	6	60
	135	5-1/4	12	6	60

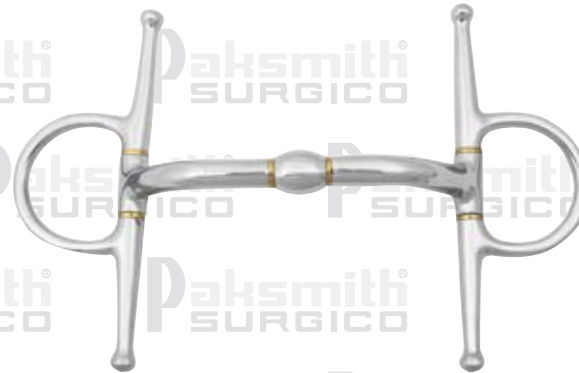

FULL CHEEK PONY DOUBLE BROKEN LINK GERMAN SILVER MOUTH (STAINLESS STEEL)

Article No.	Size (mm)	Size (Inch)	Thickness (mm)	Cheek (Inch)	Box Qty.
F30-88	115	4-1/2	16	5-1/2	80
	125	5	16	5-1/2	80
	135	5-1/4	16	5-1/2	80

FULL CHEEK DOUBLE JOINTED COPPER ROLLER MOUTH (STAINLESS STEEL)

Article No.	Size (mm)	Size (Inch)	Thickness (mm)	Cheek (Inch)	Box Qty.
F44-29	115	4-1/2	15	5-1/2	80
	125	5	15	5-1/2	80
	135	5-1/4	15	5-1/2	80

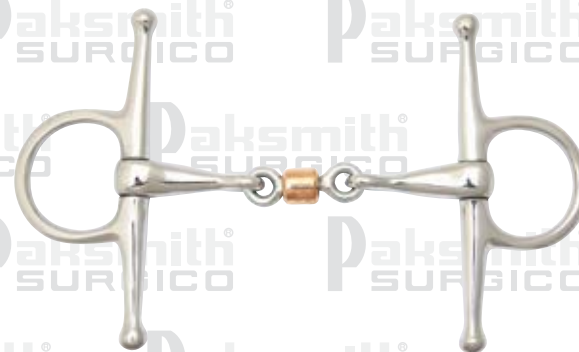

FULL CHEEK DOUBLE BROKEN LINK BLUE IRON MOUTH (STAINLESS STEEL)

Article No.	Size (mm)	Size (Inch)	Thickness (mm)	Cheek (Inch)	Box Qty.
F45-38	115	4-1/2	16	5-1/2	80
	125	5	16	5-1/2	80
	135	5-1/4	16	5-1/2	80

3 REIN BIT TRANZ ELEVATOR BROKEN LINK GERMAN SILVER MOUTH (STAINLESS STEEL)

Article No.	Size (mm)	Size (Inch)	Thickness (mm)	Cheek (Inch)	Box Qty.
F38-88	115	4-1/2	12	6	60
	125	5	12	6	60
	135	5-1/4	12	6	60



SHOW
SADDLES
JUMPING
BITS

SHOW JUMPING BITS

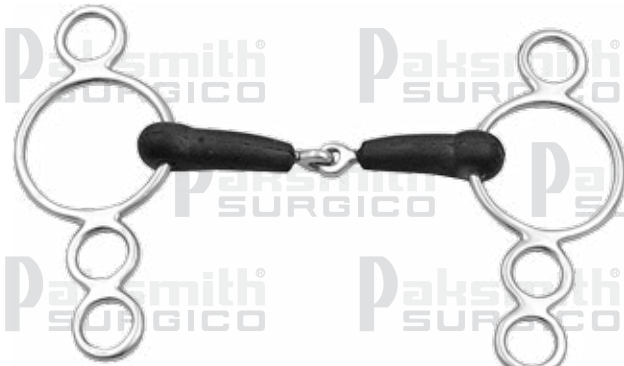

4 RING SHOW JUMPING GAG SNAFFLE RUBBER MOUTH (STAINLESS STEEL)

Article No.	Size (mm)	Size (Inch)	Thickness (mm)	Cheek (Inch)	Box Qty.
H11-56	115	4-1/2	18	7-1/2	70
	125	5	18	7-1/2	70
	135	5-1/4	18	7-1/2	70

4 RING SHOW JUMPING GAG MIDDLE LINK MOUTH (STAINLESS STEEL)

Article No.	Size (mm)	Size (Inch)	Thickness (mm)	Cheek (Inch)	Box Qty.
H12-56	115	4-1/2	16	7-1/2	70
	125	5	16	7-1/2	70
	135	5-1/4	16	7-1/2	70



4 RING SHOW JUMPING BIT, SNAFFLE HOLLOW MOUTH (STAINLESS STEEL)

Article No.	Mouth Material	Size (mm)	Size (Inch)	Thickness (mm)	Cheek (Inch)	Box Qty.
H03-03	Hollow	115	4-1/2	20	18	7-1/2
H03-29	Copper	125	5	20	18	7-1/2
H03-56	Solid (SS)	135	5-1/4	20	18	7-1/2
		145	5-3/4	20	18	7-1/2



4 RING SHOW JUMPING BIT, MIDDLE LINK GERMAN SILVER MOUTH (STAINLESS STEEL)

Article No.	Size (mm)	Size (Inch)	Thickness (mm)	Cheek (Inch)	Box Qty.
H16-88	115	4-1/2	16	7-1/2	70
	125	5	16	7-1/2	70
	135	5-1/4	16	7-1/2	70



3 RING SHOW BIT, GERMAN SILVER TRANZ UNIVERSAL MOUTH (STAINLESS STEEL)

Article No.	Size (mm)	Size (Inch)	Thickness (mm)	Cheek (Inch)	Box Qty.
H02-88	115	4-1/2	16	18	5-1/2
	125	5	16	18	5-1/2
	135	5-1/4	16	18	5-1/2



3 RING SHOW BIT, GERMAN SILVER WATERFORD UNIVERSAL MOUTH (STAINLESS STEEL)

Article No.	Size (mm)	Size (Inch)	Thickness (mm)	Cheek (Inch)	Box Qty.
H19-88	115	4-1/2	14	5-1/2	70
	125	5	14	5-1/2	70
	135	5-1/4	14	5-1/2	70



You never got so much for so little

SHOW JUMPING BITS



4 RING SHOW JUMPING GAG, SNAFFLE ROTARY MOUTH (STAINLESS STEEL)

Article No.	Mouth Material	Size (mm)	Size (Inch)	Thickness (mm)	Cheek (Inch)	Box Qty.
H15-56	SS	115	4-1/2	19	7-1/2	70
		125	5	19	7-1/2	70
		135	5-1/4	19	7-1/2	70
H14-56	SS	3 RING SHOW JUMPING GAG				70

WONDER GAG SNAFFLE COPPER MOUTH (STAINLESS STEEL)

Article No.	Mouth Material	Size (mm)	Size (Inch)	Thickness (mm)	Cheek (Inch)	Box Qty.
H01-29	Copper	115	4-1/2	14	7-1/2	100
H01-39	SW/Iron	125	5	14	7-1/2	100
H01-56	SS	135	5-1/4	14	7-1/2	100



WONDER BIT, SWEET IRON THIN WIRE MOUTH (STAINLESS STEEL)

Article No.	Size (mm)	Size (Inch)	Thickness (mm)	Cheek (Inch)	Box Qty.
H04-39	115	4-1/2	9	7-1/2	100
	125	5	9	7-1/2	100
	135	5-1/4	9	7-1/2	100



WONDER GAG SWEET IRON TWISTED WIRE MOUTH (STAINLESS STEEL)

Article No.	Mouth Material	Size (mm)	Size (Inch)	Thickness (mm)	Cheek (Inch)	Box Qty.
H05-39	SW/Iron	115	4-1/2	12	7-1/2	100
H05-29	Copper	125	5	12	7-1/2	100
H05-56	SS	135	5-1/4	12	7-1/2	100



3 RING SHOW BIT, DOUBLE BROKEN LINK GERMAN SILVER MOUTH (STAINLESS STEEL)

Article No.	Size (mm)	Size (Inch)	Thickness (mm)	Cheek (Inch)	Box Qty.
H17-88	115	4-1/2	16	18	5-1/2
	125	5	16	18	5-1/2
	135	5-1/4	16	18	5-1/2



3 RING SHOW BIT, GERMAN SILVER SNAFFLE DEMI-ANKY UNIVERSAL MOUTH (STAINLESS STEEL)

Article No.	Size (mm)	Size (Inch)	Thickness (mm)	Cheek (Inch)	Box Qty.
H18-88	115	4-1/2	16	18	5-1/2
	125	5	16	18	5-1/2
	135	5-1/4	16	18	5-1/2



SHOW JUMPING BITS



WONDER GAG SWEET IRON SNAFFLE THICK TWISTED WIRE MOUTH (STAINLESS STEEL)

Article No.	Size (mm)	Size (Inch)	Thickness (mm)	Cheek (Inch)	Box Qty.
H10-39	115	4-1/2	14	7	100
	125	5	14	7	100
	135	5-1/4	14	7	100

WONDER GAG FLEXIBLE RUBBER MOUTH (STAINLESS STEEL)

Article No.	Size (mm)	Size (Inch)	Thickness (mm)	Cheek (Inch)	Box Qty.
H13-56	115	4-1/2	22	7-1/2	100
	125	5	22	7-1/2	100
	135	5-1/4	22	7-1/2	100



WONDER GAG DOG BONE MIDDLE LINK MOUTH (STAINLESS STEEL)

Article No.	Size (mm)	Size (Inch)	Thickness (mm)	Cheek (Inch)	Box Qty.
H07-56	115	4-1/2	12	7-1/2	100
	125	5	12	7-1/2	100
	135	5-1/4	12	7-1/2	100



3 RING WONDER GAG SWEET IRON TWISTED WIRE MOUTH (STAINLESS STEEL)

Article No.	Size (mm)	Size (Inch)	Thickness (mm)	Cheek (Inch)	Box Qty.
H08-39	115	4-1/2	6	6	100
	125	5	6	6	100
	135	5-1/4	6	6	100



3 RING WONDER GAG SWEET IRON TWISTED WIRE MIDDLE LINK MOUTH (STAINLESS STEEL)

Article No.	Size (mm)	Size (Inch)	Thickness (mm)	Cheek (Inch)	Box Qty.
H09-39	115	4-1/2	10	6	100
	125	5	10	6	100
	135	5-1/4	10	6	100



3 RING WONDER GAG SWEET IRON CHAIN MOUTH (STAINLESS STEEL)

Article No.	Size (mm)	Size (Inch)	Thickness (mm)	Cheek (Inch)	Box Qty.
H06-39	115	4-1/2	12	6	100
	125	5	12	6	100
	135	5-1/4	12	6	100



PORTUGUESE VAQUERO BITS

PORTUGUESE / VAQUERO BITS



PORTUGUESE BIT LOW PORT MOUTH WITH DOUBLE CURB CHAIN (Sweet Iron)

Article No.	Size (mm)	Size (Inch)	Thickness (mm)	Box Qty.
C31-87	115	4-1/2	19	50
	125	5	19	50
	135	5-1/4	19	50
C31-39	Available with SS Mouth			

PORTUGUESE BIT SNAFFLE SS MOUTH WITH DOUBLE CURB CHAIN (Sweet Iron)

Article No.	Size (mm)	Size (Inch)	Thickness (mm)	Box Qty.
C39-39	115	4-1/2	19	50
	125	5	19	50
	135	5-1/4	19	50
C39-56	Available in complete SS			



PORTUGUESE BIT LOW PORT MOUTH WITH DOUBLE CURB CHAIN (Stainless Steel)

Article No.	Size (mm)	Size (Inch)	Thickness (mm)	Box Qty.
C31-56	105	4	19	50
	115	4-1/2	19	50
C31-01.NP	125	5	19	50
	135	5-1/4	19	50
	145	5-3/4	19	50

PORTUGUESE BIT SNAFFLE MOUTH WITH DOUBLE CURB CHAIN (Stainless Steel)

Article No.	Size (mm)	Size (Inch)	Thickness (mm)	Box Qty.
C39-87	115	4-1/2	19	50
	125	5	19	50
	135	5-1/4	19	50



VAQUERO CHEEK LOW PORT SS MOUTH WITH DOUBLE CURB CHAIN (Sweet Iron)

Article No.	Size (mm)	Size (Inch)	Thickness (mm)	Box Qty.
C55-39	125	5	19	30
	135	5-1/4	19	30



You never got so much for so little

PORTUGUESE / VAQUERO BITS



VAQUERO 14cm BIT LOW PORT MOUTH WITH DOUBLE CURB CHAIN (Sweet Iron)

Article No.	Size (mm)	Size (Inch)	Thickness (mm)	Box Qty.
C18-87	115	4-1/2	16	50
	125	5	16	50
	135	5-1/4	16	50
C18-56	Available in complete SS			

VAQUERO LONG CHEEK BIT LOW PORT MOUTH WITH DOUBLE CURB CHAIN (SS)

Article No.	Size (mm)	Size (Inch)	Thickness (mm)	Box Qty.
C19-56	115	4-1/2	16	40
C19-87	125	5	16	40
	135	5-1/4	16	40



VAQUERO BIT LOW PORT MOUTH WITH DOUBLE CURB CHAIN (Sweet Iron)

Article No.	Size (mm)	Size (Inch)	Thickness (mm)	Cheek (mm)	No.	Box Qty.
C32-87	125	5	18	182	124	30
C33-87	125	5	18	172	114	30
C35-87	125	5	18	162	104	30
C36-87	125	5	18	150	85	30
C37-87	125	5	18	142	84	30
C38-87	125	5	18	132	83	30
C38-87	100	4	16	132	83	30

VAQUERO CHEEK LOOSE LOW PORT MOUTH WITH DOUBLE CURB CHAIN (SS)

Article No.	Size (mm)	Size (Inch)	Thickness (mm)	Box Qty.
C30-56	115	4-1/2	16	40
	125	5	16	40
	135	5-1/4	16	40
C30-87	Available in complete Sweet Iron			



VAQUERO CHEEK LOOSE LOW PORT SS MOUTH WITH DOUBLE CURB CHAIN (Sweet Iron)

Article No.	Size (mm)	Size (Inch)	Thickness (mm)	Box Qty.
C54-39	125	5	19	30
	135	5-1/4	19	30
C54-87	Available in complete Sweet Iron			

www.paksmith.com

www.paksmith.com

PORTUGUESE / VAQUERO BITS



GAGS
BITS



CLASSIC ANTIQUE BIT LOW PORT SS MOUTH WITH SPECIAL HOOKS (Sweet Iron)

Article No.	Size (mm)	Size (Inch)	Thickness (mm)	Box Qty.
C42-39	125	5	16	50
	135	5-1/4	16	50
C42-56	Complete Stainless Steel			
C42-87	Complete Sweet Iron			



PORTUGUESE BIT LOW PORT MOUTH WITH DOUBLE CURB CHAIN (Stainless Steel)

Article No.	Size (mm)	Size (Inch)	Thickness (mm)	Box Qty.
C47-56	115	4-1/2	16	34
	125	5	16	34
	135	5-1/4	16	34

CLASSIC BIT LOW PORT MOUTH WITH DOUBLE CURB CHAIN (Stainless Steel)

Article No.	Size (mm)	Size (Inch)	Thickness (mm)	Box Qty.
C70	125	5	16	50
	135	5-1/4	16	50

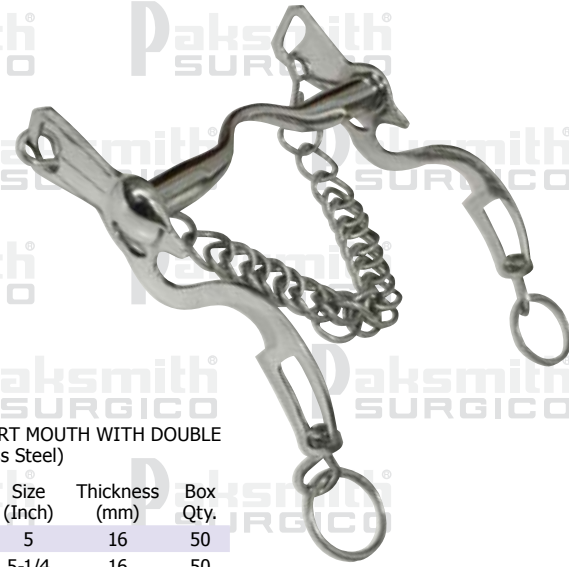

CLASSIC BIT LOW PORT MOUTH WITH DOUBLE CURB CHAIN (Stainless Steel)

Article No.	Size (mm)	Size (Inch)	Thickness (mm)	Box Qty.
C71-56	125	5	16	50
	135	5-1/4	16	50
C71-39	Sweet Iron Cheeks with SS Mouth			



FANTASY PORTUGUESE 14cm BIT LOW PORT MOUTH WITH DOUBLE CURB CHAIN (Brass)

Article No.	Size (mm)	Size (Inch)	Thickness (mm)	Box Qty.
C45-33	125	5	12	50
	135	5-1/4	12	50
C45-35	Brass Chrome Plated			



VAQUERO D-RING BIT LOW PORT MOUTH WITH DOUBLE CURB CHAIN (Brass)

Article No.	Size (mm)	Size (Inch)	Thickness (mm)	Box Qty.
C44-33	125	5	16	50
	135	5-1/4	16	50
	145	5-3/4	16	50



GAG BITS



4 REIN BIT, SWEET IRON COPPER INLAY ROLLER MOUTH (STAINLESS STEEL)

Article No.	Size (mm)	Size (Inch)	Thickness (mm)	Cheek (Inch)	Box Qty.
J04-39	125	5	10	8	70
	135	5-1/4	10	8	70
J04-87	Complete Sweet Iron				



4 REIN BIT, SWEET IRON SNAFFLE COPPER INLAY MOUTH (SWEET IRON)

Article No.	Size (mm)	Size (Inch)	Thickness (mm)	Cheek (Inch)	Box Qty.
J07-87	125	5	10	8	70
	135	5-1/4	10	8	70
J03-87	Copper Wire Wrapped Mouth				

4 REIN BIT, SNAFFLE COPPER INLAY MOUTH (STAINLESS STEEL)

Article No.	Size (mm)	Size (Inch)	Thickness (mm)	Cheek (Inch)	Box Qty.
J07-56	115	4-1/2	10	8	70
	125	5	10	8	70
	135	5-1/4	10	8	70



4 REIN BIT SWEET WATER COPPER INLAY MOUTH (STAINLESS STEEL)

Article No.	Size (mm)	Size (Inch)	Thickness (mm)	Cheek (Inch)	Box Qty.
J01-39	125	5	10	8	70
	135	5-1/4	10	8	70
J01-87	Complete Sweet Iron				



4 REIN BIT, SWEET IRON CORRECTION COPPER INLAY MOUTH (STAINLESS STEEL)

Article No.	Size (mm)	Size (Inch)	Thickness (mm)	Cheek (Inch)	Box Qty.
J06-39	115	4-1/2	12	8	70
	125	5	12	8	70
	135	5-1/4	12	8	70

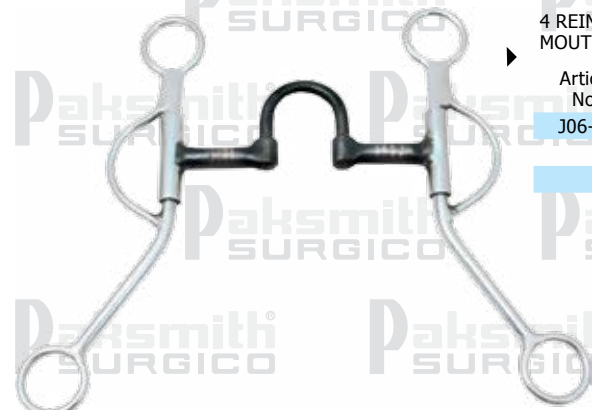

4 REIN BIT, SWEET IRON COPPER WIRE WRAP MOUTH (STAINLESS STEEL)

Article No.	Size (mm)	Size (Inch)	Thickness (mm)	Cheek (Inch)	Box Qty.
J21-39	115	4-1/2	10	8	70
	125	5	10	8	70
	135	5-1/4	10	8	70

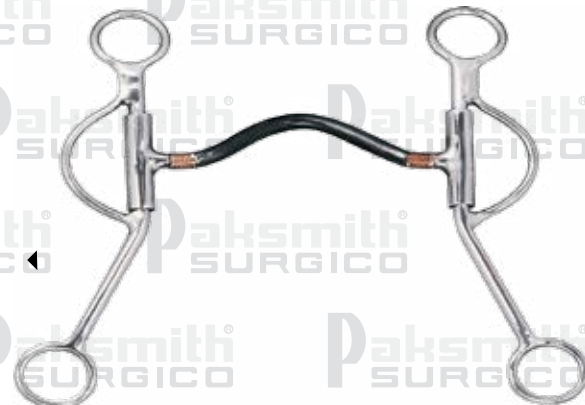

GAG BIT 3PC SWEET IRON MOUTH (STAINLESS STEEL)

Article No.	Size (mm)	Size (Inch)	Thickness (mm)	Cheek (Inch)	Box Qty.
J10-39	115	4-1/2	8	6-1/2	100
	125	5	8	6-1/2	100
	135	5-1/4	8	6-1/2	100

GAG BIT 3PC COPPER WIRE WRAPPED MOUTH (STAINLESS STEEL)

Article No.	Size (mm)	Size (Inch)	Thickness (mm)	Cheek (Inch)	Box Qty.
J08-29	115	4-1/2	10	7	100
	125	5	10	7	100
	135	5-1/4	10	7	100



GAG BIT DOUBLE BROKEN MOUTH (STAINLESS STEEL)

Article No.	Size (mm)	Size (Inch)	Thickness (mm)	Cheek (Inch)	Box Qty.
J37-56	125	5	16	6-1/2	100
	135	5-1/4	16	6-1/2	100
J37-29	With Copper Nut				



GAG BIT 3PC COPPER WIRE ROLLER MOUTH (STAINLESS STEEL)

Article No.	Size (mm)	Size (Inch)	Thickness (mm)	Cheek (Inch)	Box Qty.
J12-29	115	4-1/2	12	7	70
	125	5	12	7	70
	135	5-1/4	12	7	70

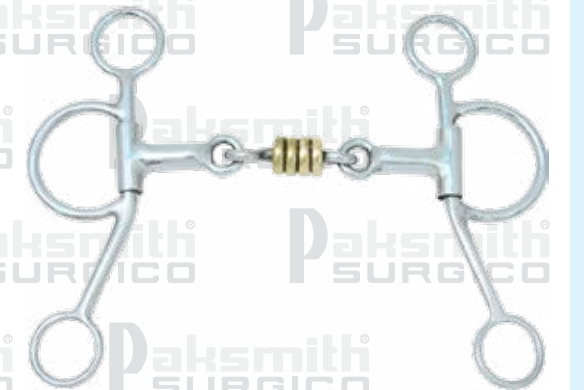

CHEEK BIT SWEET IRON SNAFFLE MOUTH (STAINLESS STEEL)

Article No.	Size (mm)	Size (Inch)	Thickness (mm)	Cheek (Inch)	Box Qty.
J14-39	115	4-1/2	12	6	100
	125	5	12	6	100
	135	5-1/4	12	6	100



3 RING GAG BIT 3PC COPPER WIRE ROLLER MOUTH (STAINLESS STEEL)

Article No.	Size (mm)	Size (Inch)	Thickness (mm)	Cheek (Inch)	Box Qty.
J38-29	115	4-1/2	12	7	100
	125	5	12	7	100
	135	5-1/4	12	7	100



Customers total satisfaction

GAG BITS

GAG BITS



GAG CHEEK BIT, SNAFFLE COPPER INLAY MOUTH (SWEET IRON)

Article No.	Size (mm)	Size (Inch)	Thickness (mm)	Cheek (Inch)	Box Qty.
J17-87	125	5	12	7	70
	135	5-1/4	12	7	70



GAG CHEEK BIT, SNAFFLE COPPER INLAY MOUTH (SWEET IRON)

Article No.	Size (mm)	Size (Inch)	Thickness (mm)	Cheek (Inch)	Box Qty.
J37-39	125	5	8	7	100
	135	5-1/4	8	7	100

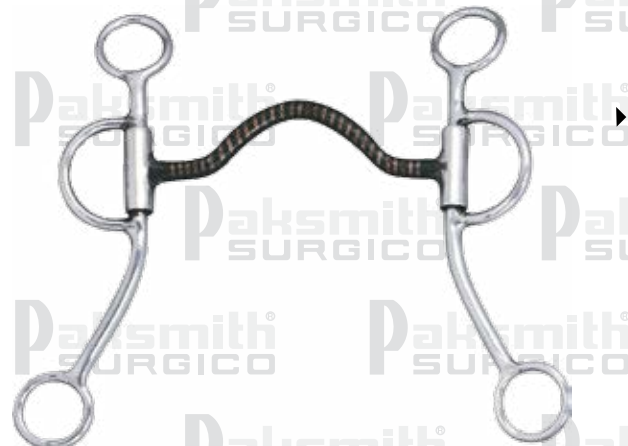

GAG CHEEK BIT, SWEET IRON COPPER INLAY MOUTH (STAINLESS STEEL)

Article No.	Size (mm)	Size (Inch)	Thickness (mm)	Cheek (Inch)	Box Qty.
J20-39	115	4-1/2	10	7	70
	125	5	10	7	70
	135	5-1/4	10	7	70



BUSHING CHEEK BIT, SWEET IRON SNAFFLE COPPER INLAY MOUTH (STAINLESS STEEL)

Article No.	Size (mm)	Size (Inch)	Thickness (mm)	Cheek (Inch)	Box Qty.
J18-39	125	5	12	7	80
	135	5-1/4	12	7	80



BUSHING CHEEK BIT, SOLID COPPER MOUTH (STAINLESS STEEL)

Article No.	Size (mm)	Size (Inch)	Thickness (mm)	Cheek (Inch)	Box Qty.
J19-29	125	5	12	7	80
	135	5-1/4	12	7	80



CHEEK BIT 3-PCS SWEET IRON TWISTED WIRE MOUTH (STAINLESS STEEL)

Article No.	Size (mm)	Size (Inch)	Thickness (mm)	Cheek (Inch)	Box Qty.
J02-39	125	5	12	8	80
	135	5-1/4	12	8	80

Customers total satisfaction

GAG BITS



GAG CHEEK BIT SW/IRON TWISTED WIRE MOUTH (STAINLESS STEEL)

Article No.	Size (mm)	Size (Inch)	Thickness (mm)	Cheek (Inch)	Box Qty.
J05-39	115	4-1/2	12	9	70
	125	5	12	9	70
	135	5-1/4	12	9	70

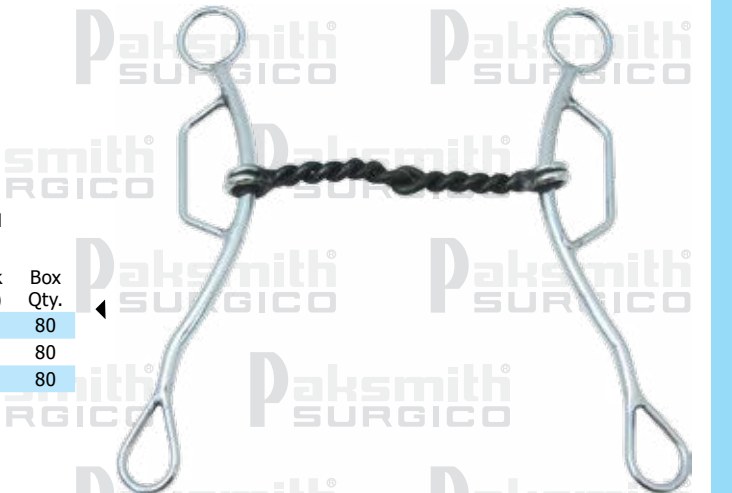

GAG CHEEK BIT, SWEET IRON THICK TWISTED WIRE MOUTH (STAINLESS STEEL)

Article No.	Mouth Material	Size (mm)	Size (Inch)	Thickness (mm)	Cheek (Inch)	Box Qty.
J13-39	SW/Iron	115	4-1/2	12	9	80
J13-29	Copper	125	5	12	9	80
J13-56	SS	135	5-1/4	12	9	80



GAG CHEEK BIT, COPPER THICK TWISTED WIRE MOUTH (STAINLESS STEEL)

Article No.	Mouth Material	Size (mm)	Size (Inch)	Thickness (mm)	Cheek (Inch)	Box Qty.
J11-29	Copper	115	4-1/2	12	9	80
J11-39	SW/Iron	125	5	12	9	80
J11-56	SS	135	5-1/4	12	9	80



TRAINING BIT CORRECTION COPPER RINGS MOUTH (SWEET IRON)

Article No.	Size (mm)	Size (Inch)	Thickness (mm)	Cheek (Inch)	Box Qty.
J23-86	115	4-1/2	10	8	70
	125	5	10	8	70
	135	5-1/4	10	8	70



GAG CHEEK BIT SW/IRON TWISTED WIRE MOUTH (STAINLESS STEEL)

Article No.	Size (mm)	Size (Inch)	Thickness (mm)	Cheek (Inch)	Box Qty.
J25-39	125	5	12	10	50
J26-39	125	5	12	8	50
J27-39	Available in Sweet Iron Chain Mouth				

GAG CHEEK BIT SW/IRON CHAIN MOUTH (STAINLESS STEEL)

Article No.	Size (mm)	Size (Inch)	Thickness (mm)	Cheek (Inch)	Box Qty.
J28-39	125	5	12	10	50





HACKAMORE 9" BRAIDED LEATHER NOSE (CS/Chrome Plated)

Article No.	Qualities Available	Colors	Box Qty.
B01-BR	02	Brown	50
B01-BK	02	Black	50
B21-BR	PONY Hackamore		



HACKAMORE 9" FLAT LEATHER NOSE (CS/Chrome Plated)

Article No.	Qualities Available	Colors	Box Qty.
B02-BR	02	Brown	50
B02-BK	02	Black	50



HACKAMORE 8-1/2" RUBBER NOSE (Stainless Steel)

Article No.	Qualities Available	Colors	Box Qty.
B05-PK	56	Pink	50
B05-WH	56	White	50



HACKAMORE 8-1/2" RUBBER NOSE (Stainless Steel)

Article No.	Qualities Available	Colors	Box Qty.
B03-WH	56	White	50
B03-PK	56	Pink	50
B03-PK.02	Available in CS/Chrome Plated		



PONY HACKAMORE 7" RUBBER NOSE (Stainless Steel)

Article No.	Qualities Available	Colors	Box Qty.
B04-WH	56	White	50
B04-PK	56	Pink	50
B04-PK.02	CS/Chrome Plated		



ENGRAVED HACKAMORE 9" FLAT LEATHER NOSE (Aluminum)

Article No.	Qualities Available	Colors	Box Qty.
B06-E.BR	51	Brown	60
B06-BR	Without Engraving		



HACKAMORE 7-1/2" LEATHER NOSE WITH CHAIN (Stainless Steel)

Article No.	Qualities Available	Colors	Box Qty.
B11-BR	56	Brown	50
B11-BK	56	Black	50



MIRACLE BIT COPPER SNAFFLE MOUTH RUBBER NOSE (SS)

Article No.	Qualities Available	Colors	Box Qty.
B12-WH	29	White	30



HACKAMORE GAG 8-RINGS CHEEK (Stainless Steel)

Article No.	Qualities Available	Box Qty.
B14-56	56	100

Leather also available



HACKAMORE 9" BRAIDED LEATHER NOSE (CS/Chrome Plated)

Article No.	Qualities Available	Colors	Box Qty.
B10-BR	02	Brown	80
B10-BK	02	Black	80

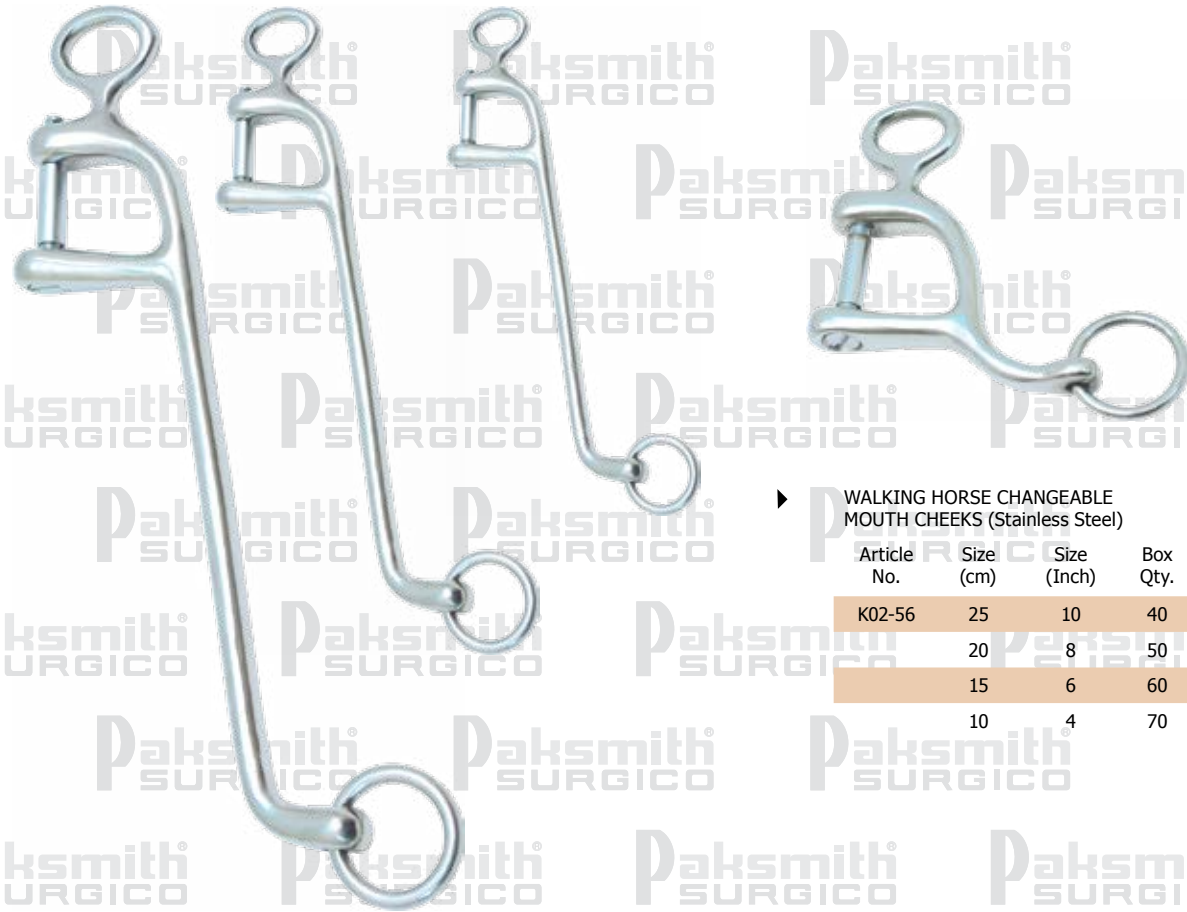

▶ WALKING HORSE CHANGEABLE MOUTH CHEEKS (Stainless Steel)

Article No.	Size (cm)	Size (Inch)	Box Qty.
K02-56	25	10	40
	20	8	50
	15	6	60
	10	4	70

◀ WALKING HORSE CHANGEABLE MOUTH CHEEKS WITH RING (Stainless Steel)

Article No.	Size (cm)	Size (Inch)	Box Qty.
K01-56	25	10	40
	20	8	50
	15	6	60



DOG BONE SOLID MOUTH (Sweet Iron)

Article No.	Size (mm)	Size (Inch)	Box Qty.
K09-29	125	5	200



DOG BONE TWISTED WIRE MOUTH (Sweet Iron)

Article No.	Size (mm)	Size (Inch)	Box Qty.
K21-39	125	5	350

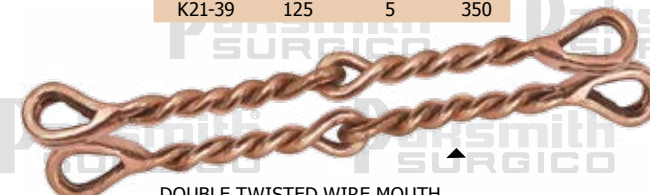

DOUBLE TWISTED WIRE MOUTH (Copper)

Article No.	Size (mm)	Size (Inch)	Box Qty.
K14-13	125	5	200



THICK TWISTED WIRE MOUTH (Stainless Steel)

Article No.	Size (mm)	Size (Inch)	Box Qty.
K15-56	125	5	150
K15-87	Available in Sweet Iron		



THIN TWISTED WIRE MOUTH (Stainless Steel)

Article No.	Size (mm)	Size (Inch)	Box Qty.
K13-56	125	5	300



DOUBLE TWISTED WIRE MOUTH (Stainless Steel)

Article No.	Size (mm)	Size (Inch)	Box Qty.
K14-56	125	5	200



SNAFFLE THIN COPPER INLAY MOUTH (Sweet Iron)

Article No.	Size (mm)	Size (Inch)	Box Qty.
K17-39	125	5	150



SNAFFLE THICK COPPER INLAY MOUTH (Sweet Iron)

Article No.	Size (mm)	Size (Inch)	Box Qty.
K18-39	125	5	150



ROLLER COPPER INLAY MOUTH (Sweet Iron)

Article No.	Size (mm)	Size (Inch)	Box Qty.
K19-39	125	5	150



SNAFFLE MOUTH (Stainless Steel)

Article No.	Size (mm)	Size (Inch)	Box Qty.
K10-56	125	5	150
K10-13	Available in Copper		



LOW PORT MOUTH (Stainless Steel)

Article No.	Size (mm)	Size (Inch)	Box Qty.
K11-56	125	5	150
K11-13	Available in Copper		



CHAIN LINK MOUTH (Sweet Iron)

Article No.	Size (mm)	Size (Inch)	Box Qty.
K16-39	125	5	300

WESTERN BITS



7-1/2" GAG LOW PORT MOUTH (STAINLESS STEEL)

Article No.	Size (mm)	Size (Inch)	Qualities Available	Box Qty.
C04	125	5	56	50

7" GAG LOW PORT MOUTH (STAINLESS STEEL)

Article No.	Size (mm)	Size (Inch)	Qualities Available	Box Qty.
C06	115	4-3/4	56	50
	125	5	56	50



7-1/2" GAG MEDIUM PORT MOUTH (STAINLESS STEEL)

Article No.	Size (mm)	Size (Inch)	Qualities Available	Box Qty.
C16	125	5	56	50

ENGRAVED CHEEK BIT COPPER MEDIUM PORT MOUTH (ALUMINUM)

Article No.	Size (mm)	Size (Inch)	Qualities Available	Box Qty.
C22-E29	125	5	29	50
C22-29	Without Engraving			



CHEEK BIT SW/IRON MEDIUM PORT MOUTH (ALUMINUM)

Article No.	Size (mm)	Size (Inch)	Qualities Available	Box Qty.
C22	125	5	87	50

WESTERN BIT LOW PORT MOUTH (SWEET IRON)

Article No.	Size (mm)	Size (Inch)	Qualities Available	Box Qty.
C21	125	5	87	40

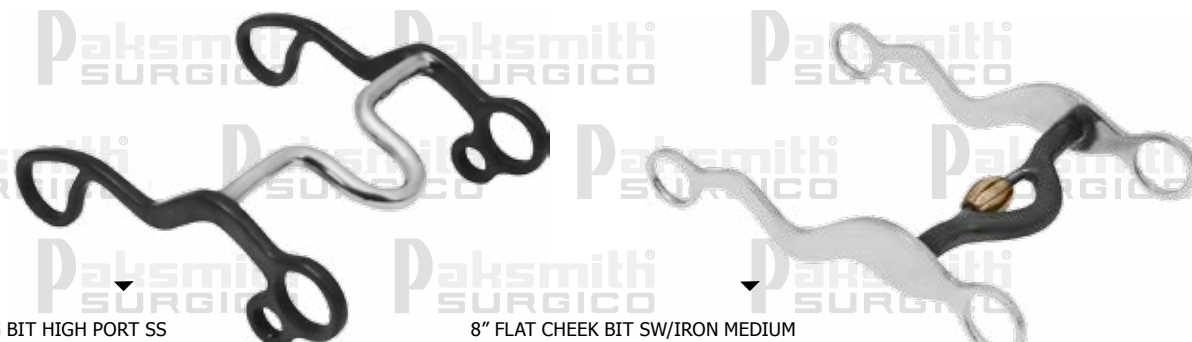

7" GAG 3 RING BIT HIGH PORT SS MOUTH (SWEET IRON)

Article No.	Size (mm)	Size (Inch)	Qualities Available	Box Qty.
C15	125	5	39	50

8" FLAT CHEEK BIT SW/IRON MEDIUM PORT COPPER ROLLER MOUTH (SS)

Article No.	Size (mm)	Size (Inch)	Qualities Available	Box Qty.
C05	125	5	39	50

Best products with best prices

WESTERN BITS



7-1/2" GAG LOW PORT MOUTH (STAINLESS STEEL)

Article No.	Size (mm)	Size (Inch)	Qualities Available	Box Qty.
C12	125	5	56	50

7-1/2" GAG 3 RING LOW PORT MOUTH (STAINLESS STEEL)

Article No.	Size (mm)	Size (Inch)	Qualities Available	Box Qty.
C13	125	5	56	50



7-1/2" GAG 4 RING LOW PORT MOUTH (STAINLESS STEEL)

Article No.	Size (mm)	Size (Inch)	Qualities Available	Box Qty.
C14	125	5	56	50

7-1/2" GAG 3 RING LOW PORT MOUTH (STAINLESS STEEL)

Article No.	Size (mm)	Size (Inch)	Qualities Available	Box Qty.
C28	125	5	56	50



7-1/2" GAG BIT LOW PORT MOUTH (CS/NICKEL PLATED)

Article No.	Size (mm)	Size (Inch)	Qualities Available	Box Qty.
C17	115	4-3/4	02	50
	125	5	02	50

7-1/2" WESTERN BIT LOW PORT MOUTH (STAINLESS STEEL)

Article No.	Size (mm)	Size (Inch)	Qualities Available	Box Qty.
C26	125	5	56	50



8-1/2" CHEEK BIT MEDIUM COPPER ROLLER MOUTH (STAINLESS STEEL)

Article No.	Size (mm)	Size (Inch)	Qualities Available	Box Qty.
C11	125	5	29	50

8-1/2" CHEEK BIT BILLY ALLEN COPPER ROLLER MOUTH (STAINLESS STEEL)

Article No.	Size (mm)	Size (Inch)	Qualities Available	Box Qty.
C10	125	5	29	50

WESTERN BITS



9" CHEEK BIT COPPER ROLLER HINGED MOUTH (STAINLESS STEEL)

Article No.	Size (mm)	Size (Inch)	Qualities Available	Box Qty.
C01	125	5	29	60



9" CHEEK BIT COPPER CORRECTION MOUTH (STAINLESS STEEL)

Article No.	Size (mm)	Size (Inch)	Qualities Available	Box Qty.
C07	125	5	29	60



9" CHEEK BIT COPPER ROLLER CORRECTION MOUTH (SS)

Article No.	Size (mm)	Size (Inch)	Qualities Available	Box Qty.
C09	125	5	29	60



9" CHEEK BIT COPPER ROLLER MOUTH (STAINLESS STEEL)

Article No.	Size (mm)	Size (Inch)	Qualities Available	Box Qty.
C23	125	5	29	60



8-1/2" CHEEK BIT COPPER ROLLER HINGED MOUTH (STAINLESS STEEL)

Article No.	Size (mm)	Size (Inch)	Qualities Available	Box Qty.
C24	125	5	29	60



8-1/2" WESTERN BIT COPPER ROLLER SPADE MOUTH (STAINLESS STEEL)

Article No.	Size (mm)	Size (Inch)	Qualities Available	Box Qty.
C08	125	5	29	60

Best products with best prices

WESTERN BITS



9" CHEEK BIT MEDIUM PORT MOUTH (STAINLESS STEEL)

Article No.	Size (mm)	Size (Inch)	Qualities Available	Box Qty.
C02	125	5	56	50



8-1/2" CHEEK BIT MEDIUM PORT MOUTH (STAINLESS STEEL)

Article No.	Size (mm)	Size (Inch)	Qualities Available	Box Qty.
C25	125	5	56	50

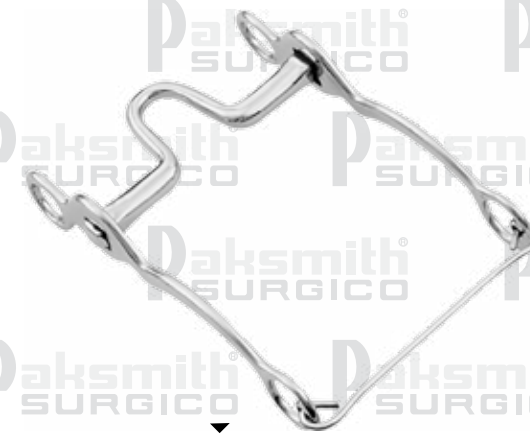

8-1/2" WESTERN BIT HIGH PORT MOUTH (STAINLESS STEEL)

Article No.	Size (mm)	Size (Inch)	Qualities Available	Box Qty.
C03	125	5	56	50



5-1/2" ARGENTINE BIT SNAFFLE MOUTH (STAINLESS STEEL)

Article No.	Size (mm)	Size (Inch)	Qualities Available	Box Qty.
F08-56	125	5	56	120
F08-01	NICKEL		01	120
F08-87	SW/IRON		87	120
F08-39	SS CHEEKS, SW/IRON MOUTH			

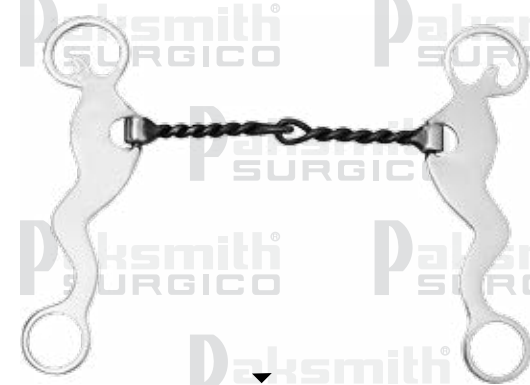

6-1/2" FLAT CHEEK SWEET IRON TWISTED WIRE MOUTH (STAINLESS STEEL)

Article No.	Size (mm)	Size (Inch)	Qualities Available	Box Qty.
G06	125	5	39	70



8" FLAT CHEEK SWEET IRON CHAIN MOUTH (STAINLESS STEEL)

Article No.	Size (mm)	Size (Inch)	Qualities Available	Box Qty.
G07	125	5	39	70

www.paksmith.com

www.paksmith.com

WESTERN BITS

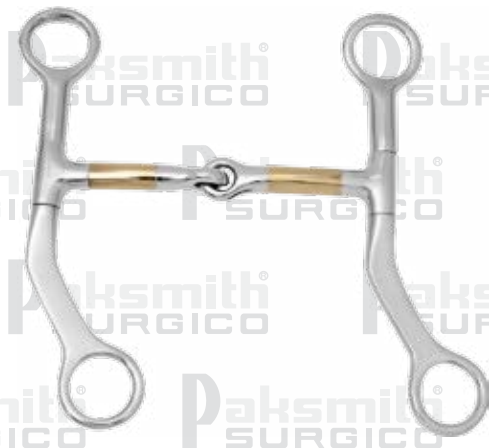
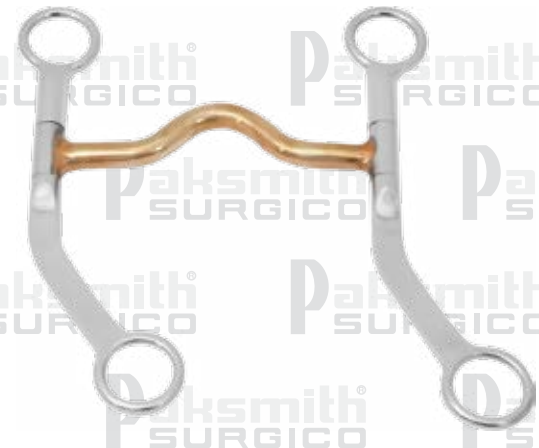

7" CHEEK BIT COPPER MEDIUM PORT MOUTH (STAINLESS STEEL)

Article No.	Size (mm)	Size (Inch)	Qualities Available	Box Qty.
E07-29	125	5	29 39	70
E07-39	SWEET IRON MOUTH			

7" CHEEK BIT COPPER SNAFFLE MOUTH (STAINLESS STEEL)

Article No.	Size (mm)	Size (Inch)	Qualities Available	Box Qty.
E12-29	125	5	29 39	70
E12-39	SWEET IRON MOUTH			

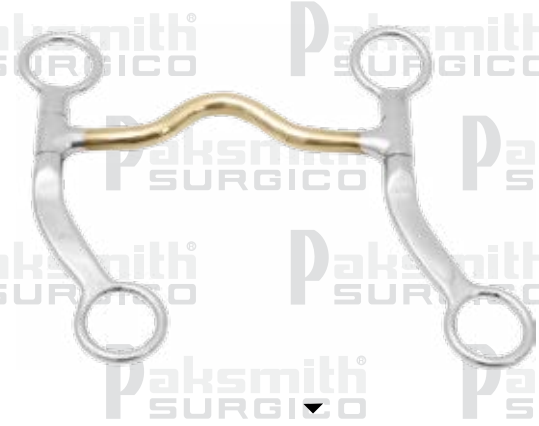

6" SHORT CHEEK BIT COPPER LOW PORT MOUTH (STAINLESS STEEL)

Article No.	Size (mm)	Size (Inch)	Qualities Available	Box Qty.
E14-29	125	5	29 39	80
E14-39	SWEET IRON MOUTH			

7" CHEEK BIT COPPER MULLEN MOUTH (STAINLESS STEEL)

Article No.	Size (mm)	Size (Inch)	Qualities Available	Box Qty.
E08-29	125	5	29 39	70
E08-39	SWEET IRON MOUTH			

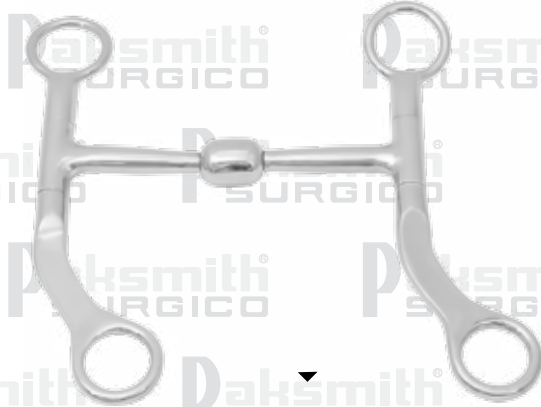

6" MYLER BUSHING CHEEK BIT HIGH PORT COPPER IN-LAY MOUTH (SS)

Article No.	Size (mm)	Size (Inch)	Qualities Available	Box Qty.
E17-56	125	5	56 39	80
E17-39	SWEET IRON MOUTH			

7" CHEEK BIT ROLLER MOUTH COPPER IN-LAY (STAINLESS STEEL)

Article No.	Size (mm)	Size (Inch)	Qualities Available	Box Qty.
E15	125	5	56 70	70

Best products with best prices

WESTERN BITS



7" CHEEK BIT SWEET IRON MULLEN MOUTH COPPER IN-LAY (SS)

Article No.	Size (mm)	Size (Inch)	Qualities Available	Box Qty.
E08-39	125	5	39 70	70

7" CHEEK BIT SWEET IRON HIGH PORT MOUTH COPPER IN-LAY (SS)

Article No.	Size (mm)	Size (Inch)	Qualities Available	Box Qty.
E03	125	5	39 70	70



7" CHEEK BIT SWEET IRON LOW PORT MOUTH COPPER IN-LAY (SS)

Article No.	Size (mm)	Size (Inch)	Qualities Available	Box Qty.
E06	125	5	39 70	70

7" CHEEK BIT SWEET IRON ROLLER MOUTH COPPER IN-LAY (SS)

Article No.	Size (mm)	Size (Inch)	Qualities Available	Cheek (Inch)	Box Qty.
E02-39	125	5	39	7	70
E42	Myler Bushing Cheek			8	70



MYLER BUSHING CHEEK BIT SWEET IRON 3 PCS MOUTH (STAINLESS STEEL)

Article No.	Size (mm)	Size (Inch)	Qualities Available	Cheek (Inch)	Box Qty.
E04	125	5	39	6	80
E54	135	5	39	8	70
E24	Without Brass Bushing			7	70

MYLER BUSHING CHEEK BIT SWEET IRON HINGED MOUTH COPPER IN-LAY (SS)

Article No.	Size (mm)	Size (Inch)	Qualities Available	Cheek (Inch)	Box Qty.
E21	125	5	39	6	80
E31	135	5-1/4	39	8	70

www.paksmith.com

www.paksmith.com

WESTERN BITS



MYLER BUSHING CHEEK BIT SWEET IRON ELBOW MOUTH COPPER IN-LAY (SS)

Article No.	Size (mm)	Size (Inch)	Qualities Available	Cheek (inch)	Box Qty.
E16	125	5	39	6	80
E26	135	5-1/4	39	8	70



MYLER BUSHING CHEEK BIT SWEET IRON MEDIUM MOUTH COPPER IN-LAY (SS)

Article No.	Size (mm)	Size (Inch)	Qualities Available	Cheek (inch)	Box Qty.
E18	125	5	39	56	80
E28	135	5-1/4	39	8	70



MYLER BUSHING CHEEK BIT SWEET IRON SNAFFLE MOUTH COPPER IN-LAY (SS)

Article No.	Size (mm)	Size (Inch)	Qualities Available	Cheek (inch)	Box Qty.
E20	125	5	39	6	80
E30	135	5-1/4	39	8	70

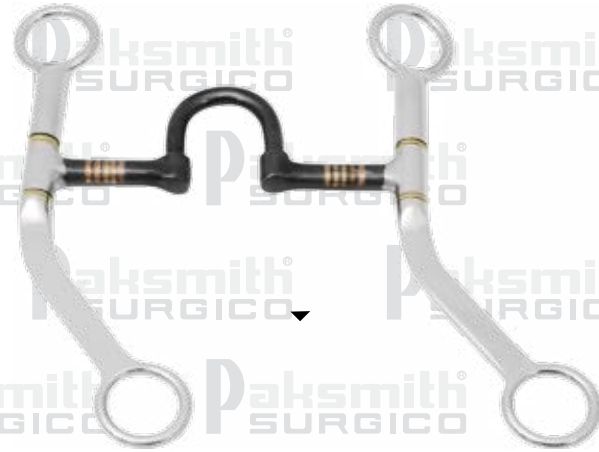

MYLER BUSHING CHEEK BIT SWEET IRON CORRECTION MOUTH COPPER IN-LAY (SS)

Article No.	Size (mm)	Size (Inch)	Qualities Available	Cheek (inch)	Box Qty.
E22	125	5	39	6	80
E32	135	5-1/4	39	8	70



MYLER BUSHING CHEEK BIT SW/IRON SPOONED HIGH PORT MOUTH COPPER IN-LAY (SS)

Article No.	Size (mm)	Size (Inch)	Qualities Available	Cheek (inch)	Box Qty.
E19	125	5	39	6	80
E29	135	5-1/4	39	8	70



MYLER BUSHING CHEEK BIT SWEET IRON LOW PORT MOUTH COPPER IN-LAY (STAINLESS STEEL)

Article No.	Size (mm)	Size (Inch)	Qualities Available	Cheek (inch)	Box Qty.
E34	125	5	39	8	70
E44	135	5-1/4	39	6	80

Best products with best prices

WESTERN BITS



8" CHEEK BIT SWEET IRON SNAFFLE MOUTH COPPER IN-LAY (SS)

Article No.	Size (mm)	Size (Inch)	Qualities Available	Box Qty.
E11-39	125	5	39	70
E11-29	Copper Snaffle Mouth			



7" CHEEK BIT SPOON COPPER IN-LAY MOUTH (STAINLESS STEEL)

Article No.	Size (mm)	Size (Inch)	Qualities Available	Box Qty.
E01	125	5	56	70

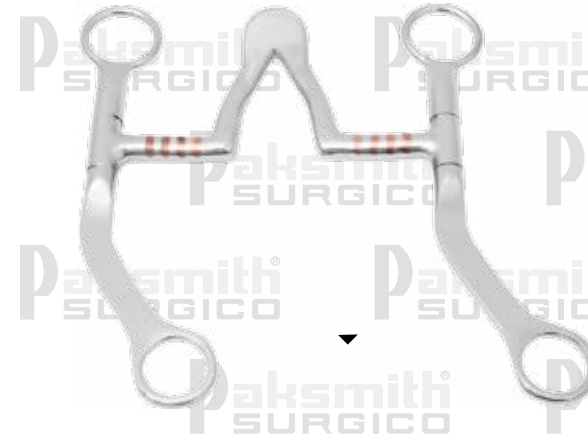

8" CHEEK BIT CATHEDRAL COPPER IN-LAY MOUTH (STAINLESS STEEL)

Article No.	Size (mm)	Size (Inch)	Qualities Available	Box Qty.
E05	125	5	56	70

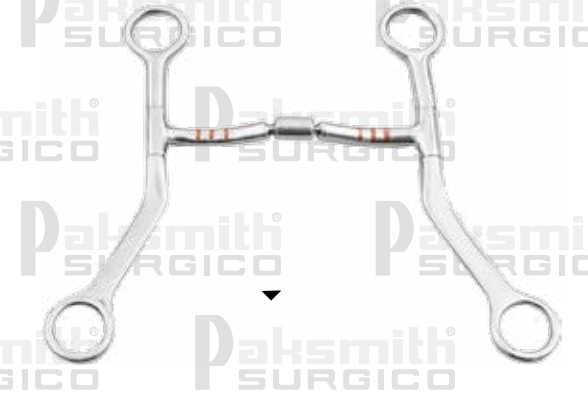

8" CHEEK BIT ROLLER COPPER IN-LAY MOUTH (STAINLESS STEEL)

Article No.	Size (mm)	Size (Inch)	Qualities Available	Box Qty.
E39-56	125	5	56	39
E39-39	Sweet Iron Mouth			
E09-56	MYLER Bushing Cheek Bit			
E09-39	MYLER Sweet Iron Mouth			



8" CHEEK BIT SWEET IRON ELBOW MOUTH COPPER IN-LAY (SS)

Article No.	Size (mm)	Size (Inch)	Qualities Available	Box Qty.
E36	125	5	39	56
				70

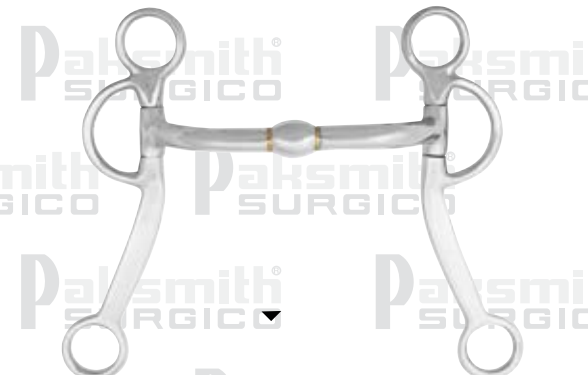

7-1/2" BUSHING CHEEK BIT SS ROLLER FORWARD MOUTH (STAINLESS STEEL)

Article No.	Size (mm)	Size (Inch)	Qualities Available	Box Qty.
E35	125	5	56	60

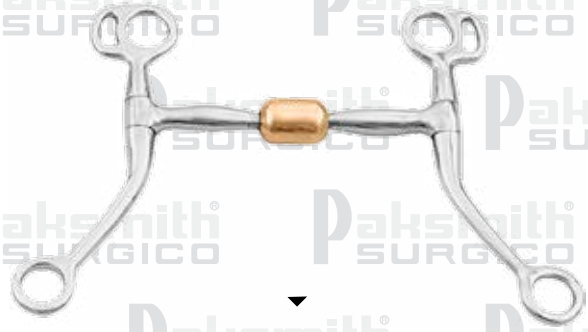

TOM THUMB BIT BILLY ALLEN COPPER ROLLER MOUTH (STAINLESS STEEL)

Article No.	Size (mm)	Size (Inch)	Qualities Available	Box Qty.
F01	125	5	29	50

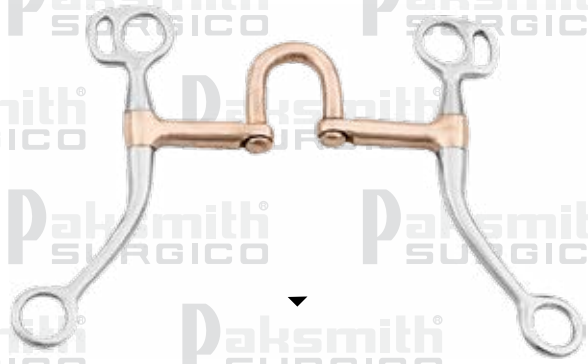

TOM THUMB BIT COPPER CORRECTION MOUTH (STAINLESS STEEL)

Article No.	Size (mm)	Size (Inch)	Qualities Available	Box Qty.
F39	125	5	29	50



TOM THUMB BIT COPPER LINK MOUTH (STAINLESS STEEL)

Article No.	Size (mm)	Size (Inch)	Qualities Available	Box Qty.
F04	125	5	29	50

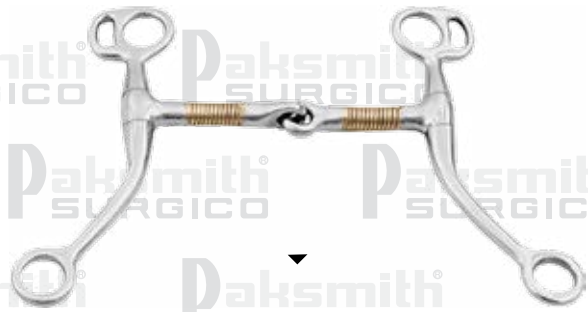

TOM THUMB BIT COPPER WIRE WRAPPED MOUTH (STAINLESS STEEL)

Article No.	Size (mm)	Size (Inch)	Qualities Available	Box Qty.
F03	125	5	29	50

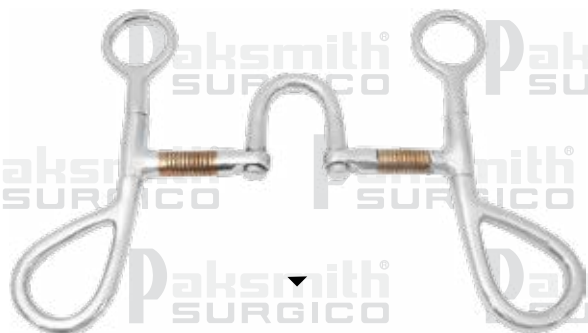

6" CHEEK BIT CORRECTION COPPER WRAPPED (STAINLESS STEEL)

Article No.	Size (mm)	Size (Inch)	Qualities Available	Box Qty.
F10	125	5	29	50



CHEEK BIT SNAFFLE COPPER MOUTH (STAINLESS STEEL)

Article No.	Size (mm)	Size (Inch)	Qualities Available	Box Qty.
F09	125	5	29	70



TOM THUMB 6" BIT BILLY ALLEN COPPER ROLLER MOUTH (STAINLESS STEEL)

Article No.	Size (mm)	Size (Inch)	Qualities Available	Box Qty.
F41	125	5	29	70



TOM THUMB 6" BIT COPPER WIRE WRAPPED MOUTH (STAINLESS STEEL)

Article No.	Size (mm)	Size (Inch)	Qualities Available	Box Qty.
F33	125	5	29	70

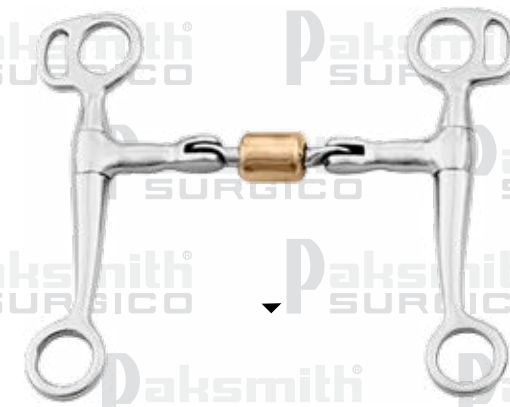

TOM THUMB 6" BIT COPPER ROLLER 3PCS MOUTH (STAINLESS STEEL)

Article No.	Size (mm)	Size (Inch)	Qualities Available	Box Qty.
F32	125	5	29	70



TOM THUMB 6" BIT COPPER LINK MOUTH (STAINLESS STEEL)

Article No.	Size (mm)	Size (Inch)	Qualities Available	Box Qty.
F35	125	5	29	70

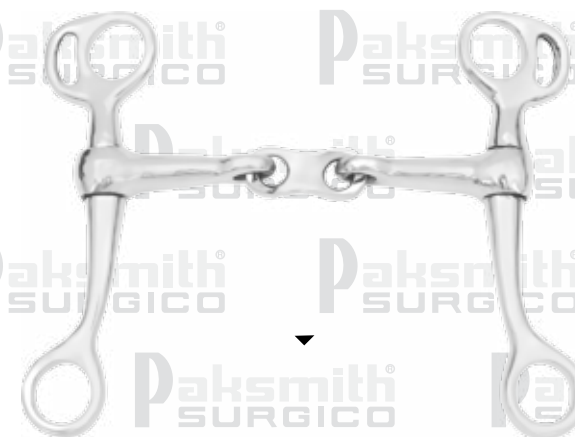

TOM THUMB 6" BIT DOG BONE LINK MOUTH (STAINLESS STEEL)

Article No.	Size (mm)	Size (Inch)	Qualities Available	Box Qty.
F34	125	5	56	70

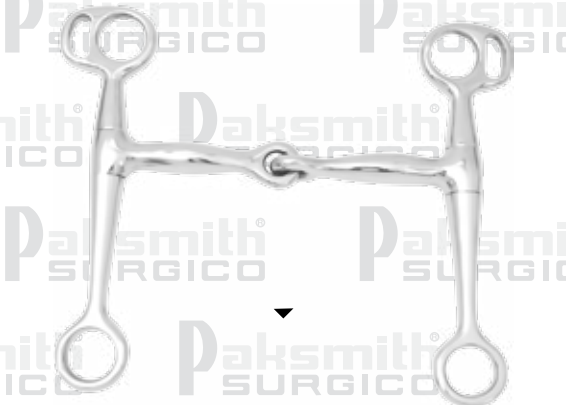

TOM THUMB 6" BIT SNAFFLE MOUTH (STAINLESS STEEL)

Article No.	Size (mm)	Size (Inch)	Qualities Available	Box Qty.
F42	125	5	56	70

WESTERN BITS

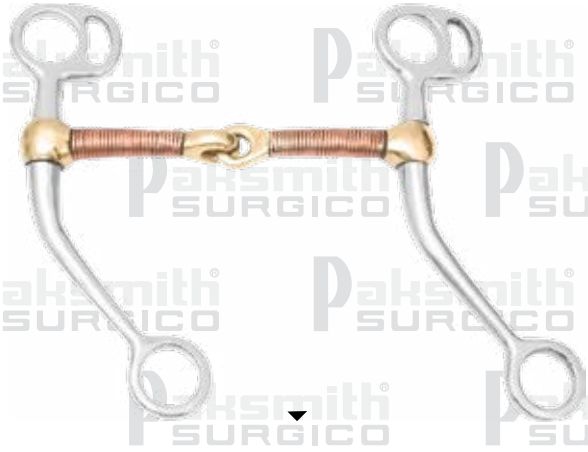

TOM THUMB BIT COPPER WIRE WRAPPED BRASS MOUTH (SS)

Article No.	Size (mm)	Size (Inch)	Qualities Available	Box Qty.
F13-36	125	5	36	29
F13-29	SS MOUTH	COPPER WIRE WRAP		60



TOM THUMB BIT COPPER SNAFFLE MOUTH (STAINLESS STEEL)

Article No.	Size (mm)	Size (Inch)	Qualities Available	Box Qty.
F17-29	125	5	29	56
	100	4	PONY	70



TOM THUMB BIT COPPER & SS ROLLER MOUTH (STAINLESS STEEL)

Article No.	Size (mm)	Size (Inch)	Qualities Available	Box Qty.
F26	125	5	29	60



TOM THUMB BIT COPPER & SS ROLLER MOUTH (STAINLESS STEEL)

Article No.	Size (mm)	Size (Inch)	Qualities Available	Box Qty.
F16	125	5	29	60
	135	5-1/4		60

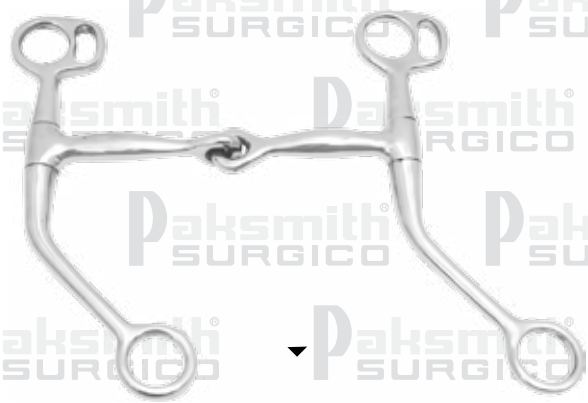

TOM THUMB BIT SNAFFLE PINCH-LESS MOUTH (STAINLESS STEEL)

Article No.	Size (mm)	Size (Inch)	Qualities Available	Box Qty.
F27-56	125	5	56	60
F27-02	135	5-1/4	02	60

Available in CS/Nickel Plated



TOM THUMB BIT SNAFFLE MOUTH (STAINLESS STEEL)

Article No.	Size (mm)	Size (Inch)	Qualities Available	Box Qty.
F17	115	4-1/2	56	02
	125	5	56	60
	135	5-1/4	56	60

Best products with best prices

WESTERN BITS



TOM THUMB BIT 3PC COPPER ROLLER MOUTH (STAINLESS STEEL)

Article No.	Size (mm)	Size (Inch)	Qualities Available	Box Qty.
F20-29	125	5	29	36
F20-36	BRASS MOUTH	COPPER ROLLER		60

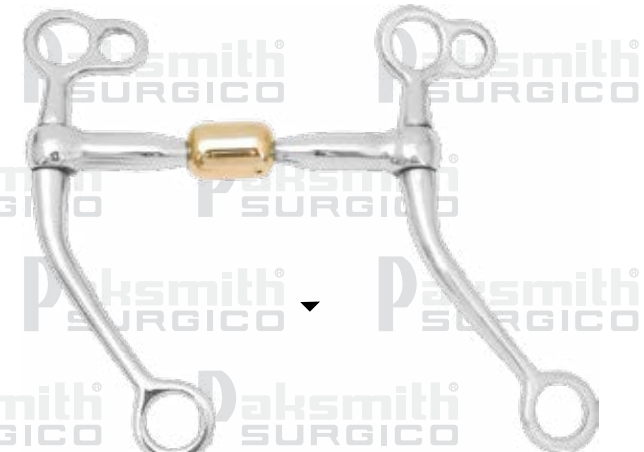

TOM THUMB BIT BILLY ALLEN COPPER MOUTH (STAINLESS STEEL)

Article No.	Size (mm)	Size (Inch)	Qualities Available	Box Qty.
F19	125	5	29	60



7-1/2" CHEEK BIT CORRECTION COPPER MOUTH (SS)

Article No.	Size (mm)	Size (Inch)	Qualities Available	Box Qty.
F23	125	5	29	60

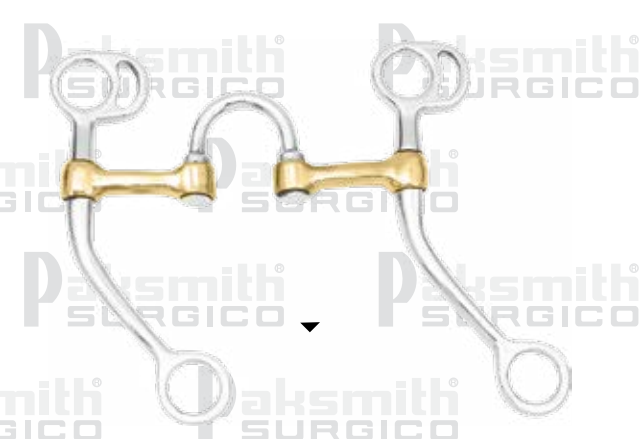

TOM THUMB BIT CORRECTION COPPER MOUTH (STAINLESS STEEL)

Article No.	Size (mm)	Size (Inch)	Qualities Available	Box Qty.
F22	125	5	29	60

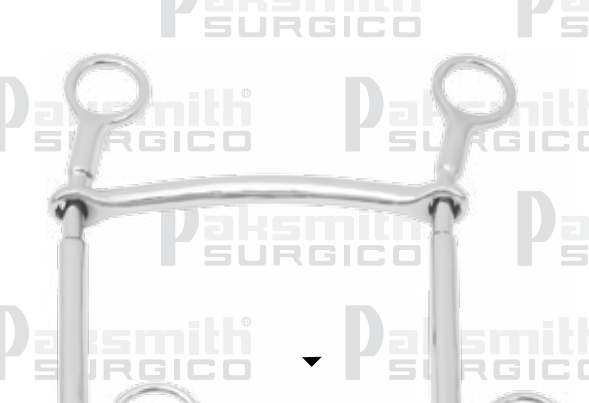

6" CHEEK BIT LOOSE FIT MULLEN MOUTH (STAINLESS STEEL)

Article No.	Size (mm)	Size (Inch)	Qualities Available	Box Qty.
F12	125	5	56	60



7" COLT TRAINING BIT SNAFFLE COPPER MOUTH (STAINLESS STEEL)

Article No.	Size (mm)	Size (Inch)	Qualities Available	Box Qty.
F14-29	125	5	29	56
F14-56	Complete	Stainless Steel		60
F36-39	Thick Twisted Wire	SW/Iron mouth		

WESTERN BITS



SPURS



6-1/2" FLAT CHEEK SWEET IRON MEDIUM PORT COPPER IN-LAY MOUTH (SS)

Article No.	Size (mm)	Size (Inch)	Qualities Available	Box Qty.
G02-39	125	5	39	56 70
G02-56 Available with SS Mouth				



6-1/2" FLAT CHEEK SWEET IRON COPPER ROLLER MOUTH (SS)

Article No.	Size (mm)	Size (Inch)	Qualities Available	Box Qty.
G01	125	5	39	70



6-1/2" FLAT CHEEK SNAFFLE MOUTH (STAINLESS STEEL)

Article No.	Size (mm)	Size (Inch)	Qualities Available	Box Qty.
G04-56	125	5	56	70



6-1/2" FLAT CHEEK SWEET IRON SNAFFLE COPPER IN-LAY MOUTH (SS)

Article No.	Size (mm)	Size (Inch)	Qualities Available	Box Qty.
G04-39	125	5	39	70



6-1/2" FLAT CHEEK SWEET IRON MEDIUM PORT COPPER IN-LAY MOUTH (SS)

Article No.	Size (mm)	Size (Inch)	Qualities Available	Box Qty.
G03	125	5	39	70



6-1/2" FLAT CHEEK SWEET IRON MULLEN COPPER IN-LAY MOUTH (SS)

Article No.	Size (mm)	Size (Inch)	Qualities Available	Box Qty.
G05	125	5	39	70



6-1/2" FLAT CHEEK SWEET IRON HIGH PORT COPPER IN-LAY MOUTH (SS)

Article No.	Size (mm)	Size (Inch)	Qualities Available	Box Qty.
G08-39	125	5	39	29 70
G08-29	Copper Mouth			



6-1/2" FLAT CHEEK SPOON COPPER IN-LAY MOUTH (STAINLESS STEEL)

Article No.	Size (mm)	Size (Inch)	Qualities Available	Box Qty.
G10-56	125	5	56	70
G10-39	Sweet Iron Mouth			



WESTERN SPURS



HAND ENGRAVED WESTERN SPUR,
CURVED SHANK (Stainless Steel)

Article No.	Size	Tread (Inch)	Shank (Inch)	Box Qty.
M12-E	Men	1-1/2	2-3/4	40
M12	Without Decoration			40

HAND ENGRAVED WESTERN SPUR,
CURVED SHANK (Stainless Steel)

Article No.	Size	Tread (Inch)	Shank (Inch)	Box Qty.
M14-E	Men	1	2-3/4	50
M14	Without Decoration			50



HAND ENGRAVED WESTERN SPUR,
LONG SHANK (Stainless Steel)

Article No.	Size	Tread (Inch)	Shank (Inch)	Box Qty.
M13-E	Men	1-1/2	3	40
	Ladies	1-1/2	3	40

HAND ENGRAVED WESTERN SPUR,
LONG SHANK (Stainless Steel)

Article No.	Size	Tread (Inch)	Shank (Inch)	Box Qty.
M13-E1	Men	1-1/2	3	40
	Ladies	1-1/2	3	40



HAND ENGRAVED WESTERN SPUR,
LONG KNOB SHANK (Stainless Steel)

Article No.	Size	Tread (Inch)	Shank (Inch)	Box Qty.
M09-E	Men	1-1/2	3	40
	Ladies	1-1/2	3	40

Best products with best prices

WESTERN SPURS



HAND ENGRAVED WESTERN SPUR,
ROSE BUD ROWEL (Stainless Steel)

Article No.	Size	Tread (Inch)	Shank (Inch)	Box Qty.
M54-E	Men	1	1-3/4	60
	Ladies	1	1-3/4	60
M54-56	Without Engraving			60

HAND ENGRAVED WESTERN SPUR,
ROSE BUD ROWEL (Stainless Steel)

Article No.	Size	Tread (Inch)	Shank (Inch)	Box Qty.
M55-E	Men	1	1-3/4	60
	Ladies	1	1-3/4	60



HAND ENGRAVED WESTERN SPUR
(German Silver)

Article No.	Size	Tread (Inch)	Shank (Inch)	Box Qty.
M22-E43	Men	1/2	1-1/2	100
	Ladies	1/2	1-1/2	100

HAND ENGRAVED WESTERN SPUR
(Stainless Steel)

Article No.	Size	Tread (Inch)	Shank (Inch)	Box Qty.
M57-E	Men	1	1-3/4	60
	Ladies	1	1-3/4	60



HAND ENGRAVED ROPING SPUR
(Stainless Steel)

Article No.	Size	Tread (Inch)	Shank (Inch)	Box Qty.
M71-E	Men	1/2	1-1/2	100
	Ladies	1/2	1-1/2	100

WESTERN SPURS



WESTERN SPUR, CURVED KNOB SHANK
(Stainless Steel)

Article No.	Size	Tread (Inch)	Shank (Inch)	Box Qty.
M11-56	Men	1-1/2	2-3/4	40
	Ladies	1-1/2	2-3/4	40

WESTERN SPUR, STRAIGHT SHANK
(Stainless Steel)

Article No.	Size	Tread (Inch)	Shank (Inch)	Box Qty.
M15-56	Men	1	2-3/4	50
	Ladies	1	2-3/4	50
M15-E	With Hand Engraving			50



WESTERN SPUR, CURVED KNOB SHANK
(Stainless Steel)

Article No.	Size	Tread (Inch)	Shank (Inch)	Box Qty.
M16-56	Men	1	2-3/4	50
	Ladies	1	2-3/4	50



WESTERN SPUR, LONG CURVED SHANK
(Stainless Steel)

Article No.	Size	Tread (Inch)	Shank (Inch)	Box Qty.
M13-56	Men	1-1/2	3	40
	Ladies	1-1/2	3	40



WESTERN SPUR, LONG KNOB SHANK
(Stainless Steel)

Article No.	Size	Tread (Inch)	Shank (Inch)	Box Qty.
M09-56	Men	1-1/2	3	40
	Ladies	1-1/2	3	40



Best products with best prices

WESTERN SPURS



GAL LEG SPUR, BIG BRASS ROWEL
(Stainless Steel)

Article No.	Size	Tread (Inch)	Shank (Inch)	Box Qty.
M20-56	Men	5/8	2	50
M20-02NP	Ladies	5/8	2	50

WESTERN SPUR, BRASS ROWEL
(Stainless Steel)

Article No.	Size	Tread (Inch)	Shank (Inch)	Box Qty.
M21-56	Men	5/8	1-3/4	100
	Ladies	5/8	1-3/4	100



WESTERN ROUND SPUR, BRASS ROWEL
(Stainless Steel)

Article No.	Size	Tread (Inch)	Shank (Inch)	Box Qty.
M17-56	Men	1	2	50
	Ladies	1	2	50



WESTERN ROPING SPUR, BRASS ROWEL
(Stainless Steel)

Article No.	Size	Tread (Inch)	Shank (Inch)	Box Qty.
M22-56	Men	1/2	1-1/2	100
M22-E02	Engraved Stamp NP		1-1/2	100
M22-02.NP	Ladies	1/2	1-1/2	100



WESTERN ROUND SPUR, ROSE BUD BRASS ROWEL
(Stainless Steel)

Article No.	Size	Tread (Inch)	Shank (Inch)	Box Qty.
M27-56	Men	1/2	1-1/2	100
	Ladies	1/2	1-1/2	100



WESTERN SPURS



WESTERN FLAT SPUR, ROSE BUD BRASS ROWEL
(Stainless Steel)

Article No.	Size	Tread (Inch)	Shank (Inch)	Box Qty.
M19-56	Child	1/2	1-1/2	120
M19-02.NP	Men	5/8	1-3/4	100
	Ladies	5/8	1-3/4	100

WESTERN FLAT SPUR, BRASS ROWEL
(Stainless Steel)

Article No.	Size	Tread (Inch)	Shank (Inch)	Box Qty.
M23-56	Men	1/2	1-1/2	100
	Ladies	1/2	1-1/2	100



WESTERN FLAT SPUR, ROUND ROWEL
(Stainless Steel)

Article No.	Size	Tread (Inch)	Shank (Inch)	Box Qty.
M18-56	Men	5/8	1-3/4	100
	Ladies	5/8	1-3/4	100



DOGGER SPUR BRASS 10-PT ROWEL
(Stainless Steel)

Article No.	Size	Tread (Inch)	Shank (Inch)	Box Qty.
M30-56	Men	3/4	1-1/2	100
	Ladies	3/4	1-1/2	100



EAGLE SPUR, ROUND ROWEL
(Brass)

Article No.	Size	Tread (Inch)	Shank (Inch)	Box Qty.
M10-33	Men	1	1-1/2	60
	Ladies	1	1-1/2	60



Best products with best prices

WESTERN SPURS



TEAM PENNER SHOW SPUR, ROUND ROWEL
(CS/Powder Coated)

Article No.	Size	Tread (Inch)	Shank (Inch)	Box Qty.
M01-D	Men	5/8	1-3/4	80
	Ladies	5/8	1-3/4	80

TEAM PENNER SPUR, ROUND ROWEL
(CS/Powder Coated)

Article No.	Size	Tread (Inch)	Shank (Inch)	Box Qty.
M01-87	Men	5/8	1-3/4	100
	Ladies	5/8	1-3/4	100



TEAM PENNER SHOW SPUR, ROUND ROWEL
(CS/Powder Coated)

Article No.	Size	Tread (Inch)	Shank (Inch)	Box Qty.
M02-D	Men	1	1-3/4	80
	Ladies	1	1-3/4	80



TEAM PENNER SPUR, ROUND ROWEL
(CS/Powder Coated)

Article No.	Size	Tread (Inch)	Shank (Inch)	Box Qty.
M02-87	Men	1	1-3/4	80
	Ladies	1	1-3/4	80



BULL SPUR STRAIGHT SHANK, 5 POINTS ROWEL
(CS/Powder Coated)

Article No.	Size	Tread (Inch)	Shank (Inch)	Box Qty.
M03-87	Men	1	2-1/4	50
M76-87	CURVED SHANK		2-1/4	50



YOUTH SPUR, ROUND ROWEL
(CS/Powder Coated)

Article No.	Material	Tread (Inch)	Shank (Inch)	Box Qty.
M05-87	Black	1/2	1-1/4	120
M05-02	CS/NP	1/2	1-1/4	120
M05-56	SS	1/2	1-1/4	120
M75-02	CS/NP	Engraved Stamp		150
M77-87	Black	Show Spur		150
M78-87	Black	Three Hearts		150



ENGLISH SPURS

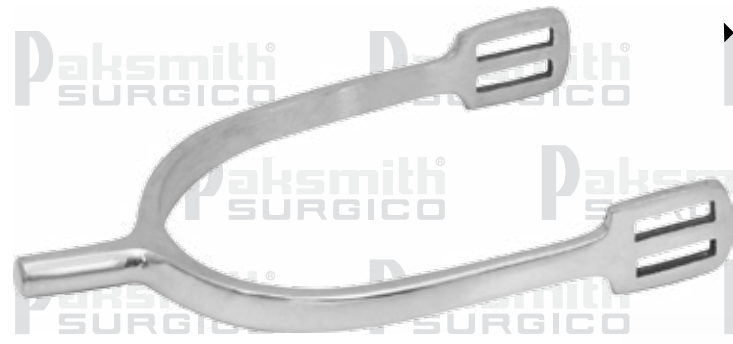

ENGLISH SLIP ON SPUR (CS/Chrome Plated)

Article No.	Size	Shank (mm)	Box Qty.
M24-02	Child	15	200
	Men	20	200
	Ladies	20	200
	Men	30	200
M24-56	Ladies	30	200
	Men	40	200
M24-56	Stainless Steel		180

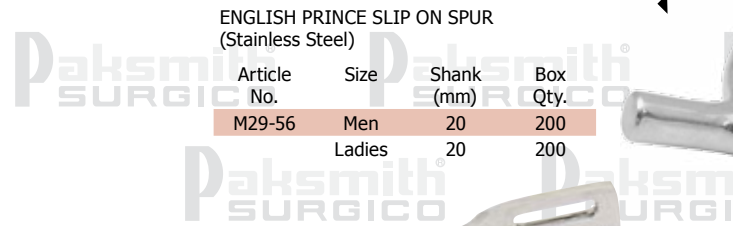

ENGLISH PRINCE SLIP ON SPUR (Stainless Steel)

Article No.	Size	Shank (mm)	Box Qty.
M29-56	Men	20	200
	Ladies	20	200



ENGLISH SLIP ON SPUR (Stainless Steel)

Article No.	Size	Shank (mm)	Box Qty.
M38-56	Child	15	180
	Men	20	180
	Ladies	25	180
M47-56	Men	30	180
	Ladies	35	180
M47-56	Men	45	180
M47-56	Available in BALL/KNOB SHANK		

Available in Different Colors

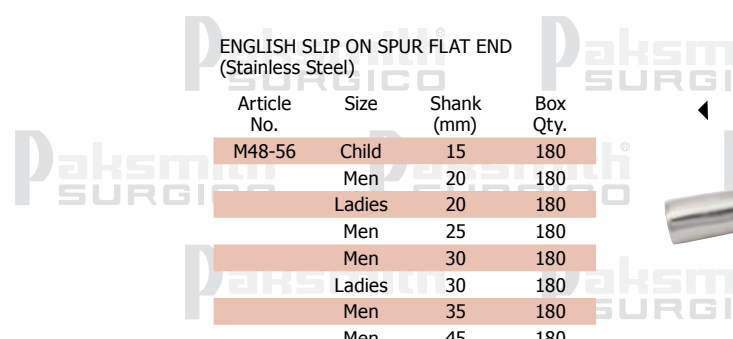

ENGLISH SLIP ON SPUR FLAT END (Stainless Steel)

Article No.	Size	Shank (mm)	Box Qty.
M48-56	Child	15	180
	Men	20	180
	Ladies	20	180
	Men	25	180
	Men	30	180
	Ladies	30	180
M49-56	Men	35	180
	Men	45	180
M49-56	FLAT END WITH BRASS ROWEL		



SLIP SPUR 1/2" CASTED MATERIAL (Stainless Steel)

Article No.	Size	Shank (mm)	Box Qty.
M26-56	Men	20	180
	Ladies	20	180

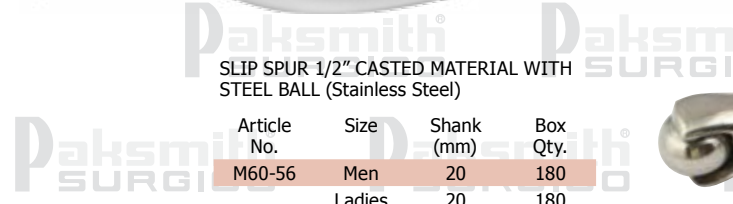

SLIP SPUR 1/2" CASTED MATERIAL WITH STEEL BALL (Stainless Steel)

Article No.	Size	Shank (mm)	Box Qty.
M60-56	Men	20	180
	Ladies	20	180

Our Quality is hard to beat

ENGLISH SPURS

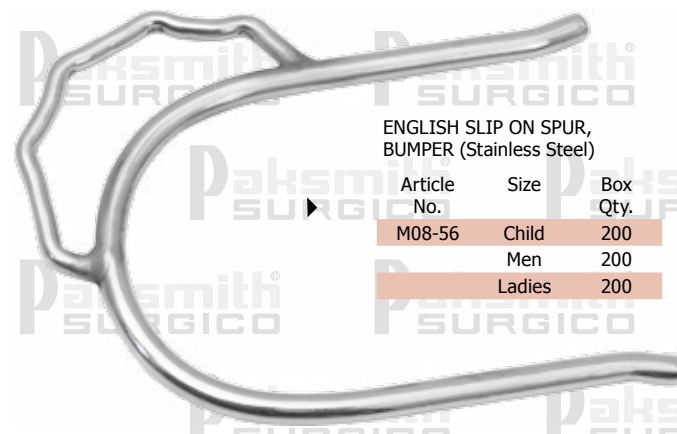

ENGLISH SLIP ON SPUR, BUMPER (Stainless Steel)

Article No.	Size	Box Qty.
M08-56	Child	200
	Men	200
	Ladies	200



Strap for English Slip on Spur

Article No.	Material
M24-NS	Black Nylon
M39-NS	High Quality Buckle & Nylon

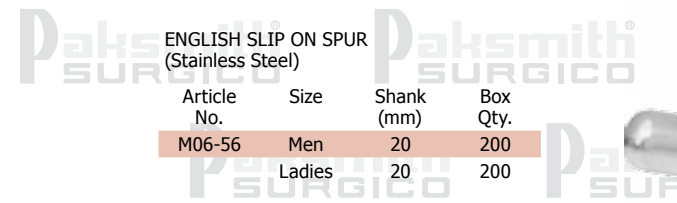

ENGLISH SLIP ON SPUR (Stainless Steel)

Article No.	Size	Shank (mm)	Box Qty.
M06-56	Men	20	200
	Ladies	20	200



ENGLISH SLIP ON SPUR, STAR ROWEL (CS/Chrome Plated)

Article No.	Size	Shank (mm)	Box Qty.
M66-02	Men	20	200
	Ladies	20	200



ENGLISH SLIP ON SPUR (German Silver)

Article No.	Size	Shank (mm)	Box Qty.
M56-33	Men	20	180
	Ladies	20	180

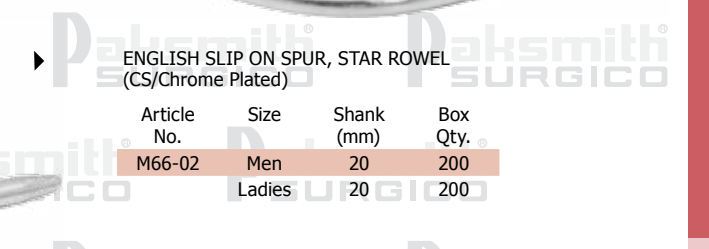

SLIP ON SPUR CURVED BRASS ROWEL (Stainless Steel)

Article No.	Size	Shank (mm)	Box Qty.
M04-56	Men	40	180
	Ladies	40	180

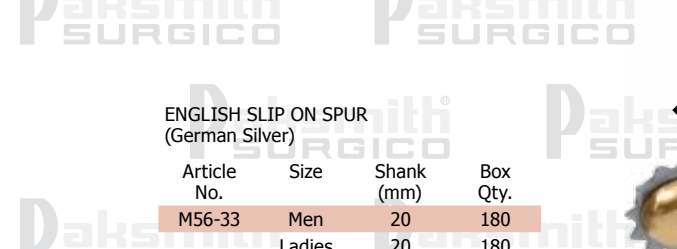

SLIP ON SPUR BRASS ROWEL (Stainless Steel)

Article No.	Size	Shank (mm)	Box Qty.
M07-56	Men	40	180
	Ladies	40	180



VAQUERO SPURS



VAQUERO SPUR, CURVED SHANK ROUND ROWEL (CS/Powder Coated)

Article No.	Material	Size	Shank (Inch)	Box Qty.
M31-62	CS/Black	Men	2	90
M31-35	Brass Plated	Men	2	90

VAQUERO SPUR, CURVED SHANK ROUND ROWEL (CS/Chrome Plated)

Article No.	Material	Size	Shank (Inch)	Box Qty.
M31-02	CS/Chromed	Men	2	90



VAQUERO SPUR, SHORT SHANK ROUND ROWEL (CS/Powder Coated)

Article No.	Material	Size	Shank (Inch)	Box Qty.
M33-62	CS/Black	Men	1-1/4	90

VAQUERO SPUR, SHORT SHANK ROUND ROWEL (CS/Brass Plated)

Article No.	Material	Size	Shank (Inch)	Box Qty.
M33-35	Brass Plated	Men	1-1/4	90



VAQUERO SPUR, SHORT SHANK ROUND ROWEL (CS/Chrome Plated)

Article No.	Material	Size	Shank (Inch)	Box Qty.
M33-02	CS/Chromed	Men	1-1/4	90

VAQUERO SPUR, SHORT SHANK 8-PT ROWEL (CS/Powder Coated)

Article No.	Material	Size	Shank (Inch)	Box Qty.
M43-62	CS/Black	Men	1-1/4	90
M43-02	CS/Chromed	Men	1-1/4	90
M43-35	Brass Plated	Men	1-1/4	90



You can get more range from us

VAQUERO SPURS



VAQUERO SPUR, CURVED KNOB SHANK (CS/Powder Coated)

Article No.	Material	Size	Shank (Inch)	Box Qty.
M51-62	CS/Black	Men	1-3/4	90
M51-02	CS/Chromed	Men	1-3/4	90
M51-35	Brass Plated	Men	1-3/4	90

VAQUERO SPUR, KNOB SHANK (CS/Powder Coated)

Article No.	Material	Size	Shank (Inch)	Box Qty.
M41-62	CS/Black	Men	1-3/4	90
M41-02	CS/Chromed	Men	1-3/4	90
M41-35	Brass Plated	Men	1-3/4	90



VAQUERO SPUR, CURVED SHANK COIN ROWEL (CS/Powder Coated)

Article No.	Material	Size	Shank (Inch)	Box Qty.
M52-62	CS/Black	Men	1-3/4	90
M52-02	CS/Chromed	Men	1-3/4	90
M52-35	Brass Plated	Men	1-3/4	90

VAQUERO SPUR, SWAN SHANK STAR ROWEL (Stainless Steel)

Article No.	Material	Size	Shank (Inch)	Box Qty.
M37-56	SS	Men	2	90

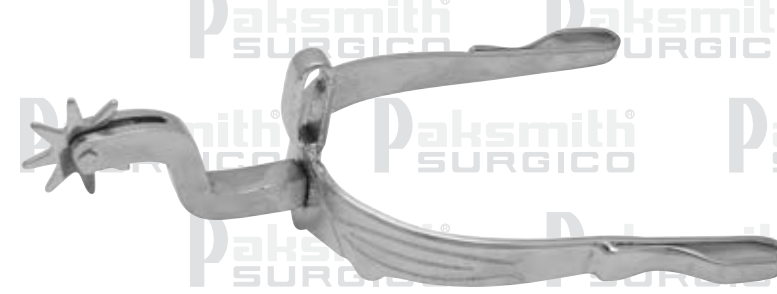

VAQUERO SPUR, SWAN SHANK STAR ROWEL (CS/Chrome Plated)

Article No.	Material	Size	Shank (Inch)	Box Qty.
M67-02	CS/Chromed	Men	2	90

VAQUERO SPUR, DOWN CURVE SHORT SHANK ROUND ROWEL (CS/Powder Coated)

Article No.	Material	Size	Shank (Inch)	Box Qty.
M42-62	CS/Black	Men	1-1/4	90
M42-02	CS/Chromed	Men	1-1/4	90
M44-62	with 8-point Rowel	Men	1-1/4	90



VAQUERO SPURS



VAQUERO LADIES SPUR, SHORT SHANK ROUND ROWEL (CS/Powder Coated)

Article No.	Material	Size	Shank (Inch)	Box Qty.
M46-62.L	CS/Black	Ladies	1-1/4	120
M46-02.L	CS/Chromed	Ladies	1-1/4	120

VAQUERO SPUR, LONG SHANK ROUND ROWEL (CS/Powder Coated)

Article No.	Material	Size	Shank (Inch)	Box Qty.
M63-02	CS/Chromed	Men	1-3/4	90
M63-62	CS/Black	Men	1-3/4	90
M64-62	with 8-point Rowel		1-3/4	90



PORTUGUESE SPUR CURVED BALL/KNOB SHANK (Stainless Steel)

Article No.	Size	Shank (mm)	Box Qty.
M70	Men	45	200

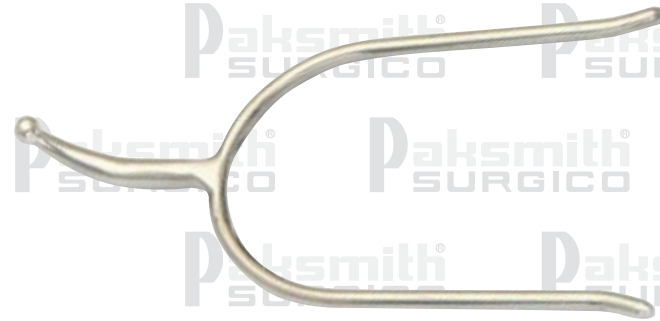

PORTUGUESE SPUR CURVED SHANK NO ROWEL (Stainless Steel)

Article No.	Size	Shank (mm)	Box Qty.
M68	Men	45	200
M69	With 10-Point Brass Rowel		



PORTUGUESE SPUR, COIN ROWEL (Stainless Steel)

Article No.	Size	Shank (mm)	Box Qty.
M62	Men	25	200



PORTUGUESE SPUR, STRAIGHT SHANK (Stainless Steel)

Article No.	Size	Shank (mm)	Box Qty.
M65-20	Men	20	200
M65-25	Men	25	200
M65-40	Men	40	200



PORTUGUESE SPUR 10-PT BRASS ROWEL (Stainless Steel)

Article No.	Size	Shank (mm)	Box Qty.
M32	Men	25	200

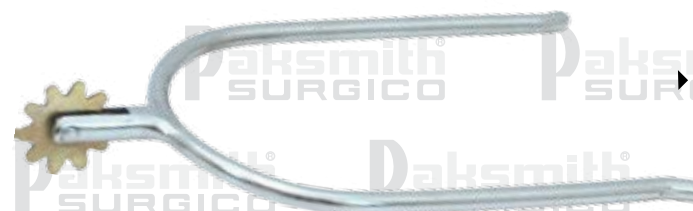

You can get more range from us

VAQUERO SPURS



VAQUERO SPUR, LONG SHANK 8-PT ROWEL (CS/Powder Coated)

Article No.	Material	Size	Shank (Inch)	Box Qty.
M64-62	CS/Black	Men	1-3/4	90

VAQUERO SPUR, LONG SHANK ROUND ROWEL (CS/Powder Coated)

Article No.	Material	Size	Shank (Inch)	Box Qty.
M63-62	CS/Black	Men	1-3/4	90



VAQUERO SPUR, CURVED SHANK 8-PT ROWEL (CS/Powder Coated)

Article No.	Material	Size	Shank (Inch)	Box Qty.
M73-62	CS/Black	Men	2	90
M73-02	CS/Chromed	Men	2	90

VAQUERO SPUR, SHORT CURVED SHANK 8-PT ROWEL (CS/Powder Coated)

Article No.	Material	Size	Shank (Inch)	Box Qty.
M64-62	CS/Black	Men	1-3/4	90
M64-02	CS/Chromed	Men	1-3/4	90



VAQUERO SPUR, DOWN CURVE SHORT SHANK 8-PT ROWEL (CS/Powder Coated)

Article No.	Material	Size	Shank (Inch)	Box Qty.
M74-62	CS/Black	Men	1	90
M74-02	CS/Chromed	Men	1	90

VAQUERO SPUR, DOWN CURVE SHORT SHANK ROUND ROWEL (CS/Powder Coated)

Article No.	Material	Size	Shank (Inch)	Box Qty.
M72-62	CS/Black	Men	1	90
M72-02	CS/Chromed	Men	1	90



VAQUERO SPUR, DOWN CURVE SHORT SHANK 8-PT ROWEL (CS/Powder Coated)

Article No.	Material	Size	Shank (Inch)	Box Qty.
M44-62	CS/Black	Men	1-1/4	90
M44-02	CS/Chromed	Men	1-1/4	90

VAQUERO SPUR, LONG SHANK ROUND ROWEL (CS/Powder Coated)

Article No.	Material	Size	Shank (Inch)	Box Qty.
M63-02	CS/Chromed	Men	1-3/4	90
M64-02	CS/Chromed with 8-PT Rowel			90



CAVESONS



LEATHER STRAPS FOR VAQUERO SPURS
(Leather)

Article No.	Size (cm)	Color	Box Qty.
M45-BK	90	Black	300
M45-BR	90	Brown	300



CAVESON WITH TWO LONGER PILLAR
(CS/POWDER COATED)

Article No.	Color	Box Qty.
K05-4T	CS/Black	120
K05-4T.BK	Black Leather	120
K05-4T.BR	Brown Leather	120



CAVESON WITH TWO SHORTER RINGS
(CS/POWDER COATED)

Article No.	Color	Box Qty.
K05-3T	Black	200
K05-3T.BK	Black Leather	
K05-3T.BR	Brown Leather	



CAVESON LEATHER COVER WITH 2
RINGS (CS)

Article No.	Color	Box Qty.
K05-2T.BK	Black	200
K05-2T.BR	Brown	200



CAVESON WITHOUT RINGS
(CS/POWDER COATED)

Article No.	Color	Box Qty.
K05-2T	Black	200
K05-2T.06	Zinc	200



CAVESON WITH TWO SHORTER RINGS
(CS/POWDER COATED)

Article No.	Color	Box Qty.
K37	Black	200

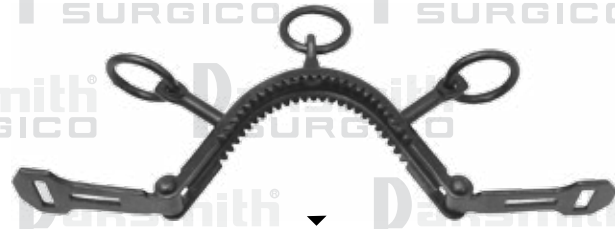

CAVESON WITH THREE RINGS (CS/
SWEET IRON)

Article No.	Color	Box Qty.
K05-1T	Black	100



CARRIAGES
LAMPS

CARRIAGE LAMPS



COACH LAMP SHINE FINISH (STAINLESS STEEL) Sold in Pair *

Article No.	Dia Meter (mm)	Material	Box Qty.
B51-56	120	SS	8
140	140	SS	6
155	155	SS	6

COACH LAMP SHINE FINISH (BRASS) Sold in Pair *

Article No.	Dia Meter (mm)	Material	Box Qty.
B51-33	120	Brass	8
B51-28	140	Brass/Black	6
155	155	Brass	6



COACH LAMP SHINE & BLACK FINISH (STAINLESS STEEL) Sold in Pair *

Article No.	Dia Meter (mm)	Material	Box Qty.
B51-30	120	SS/Black	8
140	140	SS/Black	6
155	155	SS/Black	6

COACH LAMP SHINE & BLACK FINISH (STAINLESS STEEL) Sold in Pair *

Article No.	Dia Meter (mm)	Material	Box Qty.
B52-30	120	SS/Black	8
B52-56	140	SS	6
B52-28	155	Brass/Black	6



COACH LAMP SHINE & BLACK FINISH (STAINLESS STEEL) Sold in Pair *

Article No.	Dia Meter (mm)	Material	Box Qty.
B49-30	120	SS/Black	8
140	140	SS/Black	6
155	155	SS/Black	6



WOODEN BOX FOR COACH LAMP (Without Lamps)

Article No.	Color	Box Qty.
B51-BOX	Black	2
B61-BOX	Black	2

* OPTIONS AVAILABLE: 12V LED BULB, WOODEN BOX SOLD SEPARATELY

Continued progress through innovation

CARRIAGE LAMPS



COACH LAMP 3 SIDES MIRROR SHINY FINISH (BRASS) Sold in Pair *

Article No.	Dia Meter (mm)	Material	Box Qty.
B60-28	110	Brass/Black	6
B60-30	110	SS/Black	6
B60-33	110	Brass	6

COACH LAMP SHINY FINISH (STAINLESS STEEL) Sold in Pair *

Article No.	Dia Meter (mm)	Material	Box Qty.
B62-30	120	SS/Black	8
B62-28	140	Brass/Black	6
B62-33	155	Brass	6



PONY COACH LAMP SHINY FINISH (STAINLESS STEEL) Sold in Pair *

Article No.	Dia Meter (mm)	Material	Box Qty.
B61-30	120	SS/Black	8
B61-28	140	Brass/Black	6
B61-33	155	Brass	6



All coach lamps get holders free of cost

MEDIUM COACH LAMP SHINY FINISH 12V (STAINLESS STEEL) Sold in Pair *

Article No.	Dia Meter (mm)	Material	Box Qty.
B58-30	120	SS/Black	8
B58-28	140	Brass/Black	6
B58-33	155	Brass	6



COACH LAMP EAGLE 7 SIDES MIRROR SHINY FINISH (SS) Sold in Pair *

Article No.	Material	Box Qty.
B59-30	SS/Black	6
B59-28	Brass/Black	6

www.paksmith.com

www.paksmith.com

CARRIAGE LAMPS



BACK LAMP SHINE & BLACK FINISH (BRASS) Sold in Single *

Article No.	Dia Meter (mm)	Material	Box Qty.
B50-28	95	Brass/Black	16
B50-30	95	SS/Black	16

PONY BACK LAMP SHINE & BLACK FINISH (BRASS) Sold in Single *

Article No.	Dia Meter (mm)	Material	Box Qty.
B30-28	80	Brass/Black	16
B30-30	80	SS/Black	16

COACH LAMP 6 SIDES MIRROR SHINY FINISH (STAINLESS STEEL) Sold in Pair *

Article No.	Dia Meter	Material	Box Qty.
B48-30	Standard	SS/Black	8
		SS/White	8



COACH LAMP HORSE SHOE SHINE & BLACK FINISH (BRASS) Sold in Pair *

Article No.	Material	Box Qty.
B55-30	SS/Black	6
B55-28	Brass/Black	6
B55-33	Brass	6
B55-56	SS	6

COACH LAMP SHINY FINISH (STAINLESS STEEL) Sold in Pair *

Article No.	Dia Meter (mm)	Material	Box Qty.
B29-28	190	Brass/Black	6
B29-30	190	SS/Black	6

Continued progress through innovation

CARRIAGE LAMPS



PONY COACH LAMP SHINE & BLACK FINISH (STAINLESS STEEL) Sold in Pair *

Article No.	Dia Meter (mm)	Material	Box Qty.
B73-30	140	SS/Black	6
B73-28	140	Brass/Black	6

PONY COACH LAMP SHINY FINISH (STAINLESS STEEL) Sold in Pair *

Article No.	Dia Meter (mm)	Material	Box Qty.
B64-56	120	SS	8
B64-30	120	SS/Black	8

PONY VICTORIA COACH LAMP SHINE & BLACK (STAINLESS STEEL) Sold in Pair *

Article No.	Dia Meter (mm)	Material	Box Qty.
B68-30	140	SS/Black	6
B68-28	140	Brass/Black	6



COACH LAMP SHINE & BLACK FINISH (STAINLESS STEEL) Sold in Pair *

Article No.	Dia Meter (mm)	Material	Box Qty.
B63-30	155	SS/Black	6
B63-28	155	Brass/Black	6

COACH LAMP SHINY FINISH (STAINLESS STEEL) Sold in Pair *

Article No.	Dia Meter (mm)	Material	Box Qty.
B67-30	180	SS/Black	6
B67-28	180	Brass/Black	6

COACH LAMP SHINE & BLACK FINISH (STAINLESS STEEL) Sold in Pair *

Article No.	Dia Meter (mm)	Material	Box Qty.
B65-30	160	SS/Black	6
B65-28	160	Brass/Black	6

CARRIAGE LAMPS



COACH LAMP 3 SIDES MIRROR SHINY FINISH (STAINLESS STEEL) Sold in Pair *

Article No.	Dia Meter (mm)	Material	Box Qty.
B69-30	110	SS/Black	6
B69-28	110	Brass/Black	6

COACH LAMP 3 SIDES MIRROR SHINY FINISH (STAINLESS STEEL) Sold in Pair *

Article No.	Dia Meter (mm)	Material	Box Qty.
B70-28	110	Brass/Black	6
B70-30	110	SS/Black	6

COACH LAMP 3 SIDES MIRROR SHINY FINISH (STAINLESS STEEL) Sold in Pair *

Article No.	Dia Meter (mm)	Material	Box Qty.
B71-30	110	SS/Black	6
B71-28	110	Brass/Black	6



HEX COACH LAMP 7 SIDES MIRROR SHINY FINISH (BRASS) Sold in Pair *

Article No.	Dia Meter (mm)	Material	Box Qty.
B72-28	180	Brass/Black	6
B72-30	180	SS/Black	6

COACH LAMP 2 SIDES MIRROR SHINY FINISH (STAINLESS STEEL) Sold in Pair *

Article No.	Dia Meter (mm)	Material	Box Qty.
B66-28	110	Brass/Black	6
B66-30	110	SS/Black	6



SEMINI
HOOF
KNIVES

HOOF KNIVES



HOOF KNIFE WIDE BLADE, WHITE WOOD HANDLE (Japanese Stainless Steel)

Article No.	Side	Material	Handle	Box Qty.
N01-15	RH	J2	Wood	280
	LH	J2	Wood	280

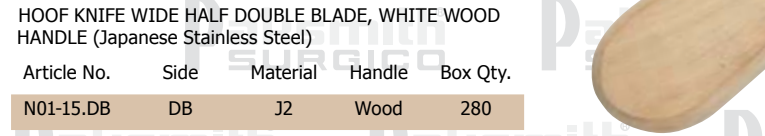

HOOF KNIFE WIDE HALF DOUBLE BLADE, WHITE WOOD HANDLE (Japanese Stainless Steel)

Article No.	Side	Material	Handle	Box Qty.
N01-15.DB	DB	J2	Wood	280



HOOF KNIFE WIDE FULL DOUBLE BLADE, WHITE WOOD HANDLE (Japanese Stainless Steel)

Article No.	Side	Material	Handle	Box Qty.
N01-15.FD	FD	J2	Wood	280



HOOF KNIFE NARROW BLADE, BLACK WOOD HANDLE (Japanese Stainless Steel)

Article No.	Side	Material	Handle	Box Qty.
N04-15BK	RH	J2	Wood	280
	LH	J2	Wood	280
	DB	J2	Wood	280



HOOF KNIFE NARROW HALF DOUBLE BLADE, WHITE WOOD HANDLE (Japanese Stainless Steel)

Article No.	Side	Material	Handle	Box Qty.
N04-15.DB	DB	J2	Wood	280



HOOF KNIFE NARROW BLADE, WHITE WOOD HANDLE (Japanese Stainless Steel)

Article No.	Side	Material	Handle	Box Qty.
N04-15	RH	J2	Wood	280
	LH	J2	Wood	280



HOOF KNIFE NARROW BLADE RED WOOD HANDLE (Japanese Stainless Steel) Aesculap

Article No.	Side	Material	Handle	Box Qty.
N05-15RD	RH	J2	Wood	280
N05-15GR	LH	J2	Wood	280



DIFFERENT COLOR WOOD AVAILABLE

We know how to manufacture your ideas

HOOF KNIVES



PROFESSIONAL HOOF KNIFE REGULAR WOOD HANDLE (Japanese Stainless Steel)

Article No.	Side	Material	Handle	Box Qty.
N55-15	RH	J2	Wood	288
	LH	J2	Wood	288
N55-37	RH	1095	Wood	288

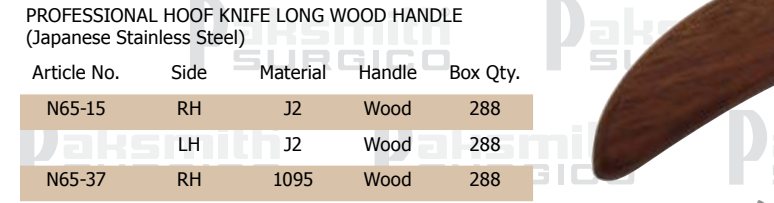

PROFESSIONAL HOOF KNIFE LONG WOOD HANDLE (Japanese Stainless Steel)

Article No.	Side	Material	Handle	Box Qty.
N65-15	RH	J2	Wood	288
	LH	J2	Wood	288
N65-37	RH	1095	Wood	288



PROFESSIONAL SPECIAL KNIFE SHARP EDGE WOOD HANDLE (Japanese Stainless Steel)

Article No.	Side	Material	Handle	Box Qty.
N82-15	RH	J2	Wood	288
	LH	J2	Wood	288



PROFESSIONAL HOOF KNIFE SHARP EDGE WOOD HANDLE (Japanese Stainless Steel)

Article No.	Side	Material	Handle	Box Qty.
N50-15	RH	J2	Wood	288
	LH	J2	Wood	288



PROFESSIONAL HOOF KNIFE SHARP EDGE WOOD HANDLE (Japanese Stainless Steel)

Article No.	Side	Material	Handle	Box Qty.
N07-15	RH	J2	Wood	240
	LH	J2	Wood	240
N07-37	RH	1095	Wood	240



PROFESSIONAL HOOF KNIFE SHARP EDGE WOOD HANDLE WITH BRASS TOPPER (Japanese Stainless Steel)

Article No.	Side	Material	Handle	Box Qty.
N70-15	RH	J2	Wood	240
	LH	J2	Wood	240



PROFESSIONAL HOOF KNIFE SHARP EDGE WOOD HANDLE (Japanese Stainless Steel)

Article No.	Side	Material	Handle	Box Qty.
N13-15	RH	J2	Wood	288
	LH	J2	Wood	288



HOOF KNIVES



HOOF KNIFE WIDE BLADE ECONOMY (Stainless Steel)

Article No.	Side	Material	Handle	Box Qty.
N01-57	RH	SS	Wood	280
	LH	SS	Wood	280

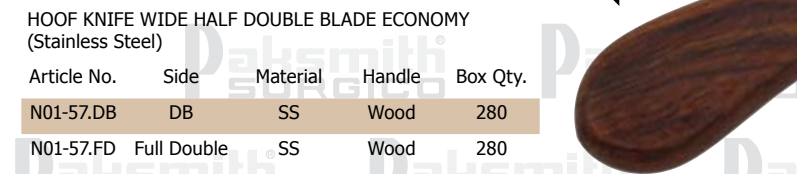

HOOF KNIFE WIDE HALF DOUBLE BLADE ECONOMY (Stainless Steel)

Article No.	Side	Material	Handle	Box Qty.
N01-57.DB	DB	SS	Wood	280
N01-57.FD	Full Double	SS	Wood	280



HOOF KNIFE NARROW HALF DOUBLE BLADE ECONOMY (Stainless Steel)

Article No.	Side	Material	Handle	Box Qty.
N04-57.DB	DB	SS	Wood	280

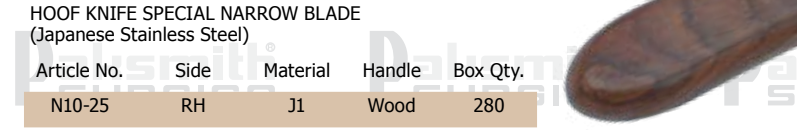

HOOF KNIFE SPECIAL NARROW BLADE (Japanese Stainless Steel)

Article No.	Side	Material	Handle	Box Qty.
N10-25	RH	J1	Wood	280
	LH	J1	Wood	280



BOT EGG KNIFE ECONOMY (Stainless Steel)

Article No.	Material	Handle	Box Qty.
N20-57	SS	Wood	300
N20-57W	SS	White Wood	300



HOOF KNIFE WIDE BLADE ECONOMY (Stainless Steel)

Article No.	Side	Material	Handle	Box Qty.
N01-57.LH	LH	SS	Wood	280
	RH	SS	Wood	280



HOOF KNIFE NARROW BLADE ECONOMY (Stainless Steel)

Article No.	Side	Material	Handle	Box Qty.
N04-57	LH	SS	Wood	280
	RH	SS	Wood	280
N06-57	RH	EXTRA NARROW		280

We know how to manufacture your ideas

HOOF KNIVES



HOOF KNIFE WIDE FULL DOUBLE BLADE ECONOMY (Stainless Steel)

Article No.	Side	Material	Handle	Box Qty.
N01-58.FD	FD	SS	Plastic	280
N01-58.DB	Half Double	SS	Plastic	280

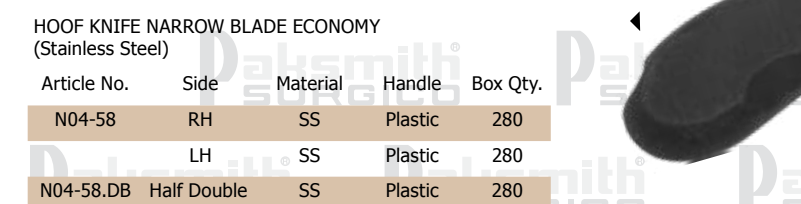

HOOF KNIFE NARROW BLADE ECONOMY (Stainless Steel)

Article No.	Side	Material	Handle	Box Qty.
N04-58	RH	SS	Plastic	280
	LH	SS	Plastic	280
N04-58.DB	Half Double	SS	Plastic	280



HOOF KNIFE EXTRA NARROW BLADE ECONOMY (Stainless Steel)

Article No.	Side	Material	Handle	Box Qty.
N06-58	LH	SS	Plastic	300
	RH	SS	Plastic	300

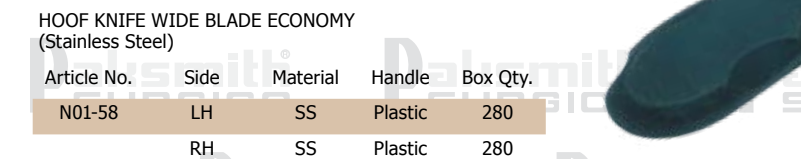

HOOF KNIFE WIDE BLADE ECONOMY (Stainless Steel)

Article No.	Side	Material	Handle	Box Qty.
N01-58	LH	SS	Plastic	280
	RH	SS	Plastic	280



JC SHORTY KNIFE SHARP EDGE WOOD HANDLE (Stainless Steel)

Article No.	Side	Material	Handle	Box Qty.
N12-57	RH	SS	Wood	280
	LH	SS	Wood	280

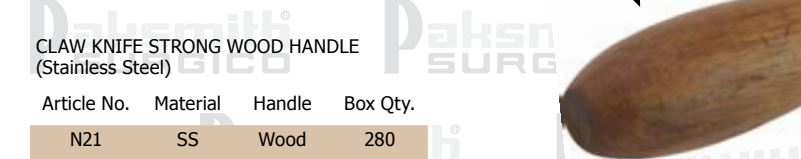

CLAW KNIFE STRONG WOOD HANDLE (Stainless Steel)

Article No.	Material	Handle	Box Qty.
N21	SS	Wood	280



HOOF KNIFE L-SHAPE LONG WOOD HANDLE (Stainless Steel)

Article No.	Side	Material	Handle	Box Qty.
N40-15	LH	J2	Wood	240
	RH	J2	Wood	240

www.paksmith.com

www.paksmith.com

HOOF KNIVES



LOOP KNIFE BLACK WOOD HANDLE
(Japanese Stainless Steel)

Article No.	Material	Handle	Box Qty.
N38-25BK	J1	Wood	180



LOOP KNIFE ECONOMY WOOD HANDLE
(Stainless Steel)

Article No.	Material	Handle	Box Qty.
N38-57	SS	Regular	200
N48-57	SS	Long	200

PROFESSIONAL LOOP KNIFE LONG HANDLE
(Japanese Stainless Steel)

Article No.	Material	Handle	Box Qty.
N39-25	J1	Long	200



SMALL LOOP ABSCESS KNIFE WOOD HANDLE
(Japanese Stainless Steel)

Article No.	Material	Handle	Box Qty.
N46-15	J1	Wood	280

MEDIUM LOOP ABSCESS KNIFE 15mm WOOD HANDLE
(Japanese Stainless Steel)

Article No.	Material	Handle	Box Qty.
N66-25	J1	Wood	250



LARGE LOOP ABSCESS KNIFE 20mm WOOD HANDLE
(Japanese Stainless Steel)

Article No.	Material	Handle	Box Qty.
N67-25	J1	Wood	250

We know how to manufacture your ideas

HOOF KNIVES



HOOF KNIFE DOUBLE BLADE AND LOOP WOOD HANDLE
(Japanese Stainless Steel)

Article No.	Material	Handle	Box Qty.
N61-25.DB	J1	Wood	180
N81-25.DB	J1	Large Loop	180

DUAL LOOP SMALL & LARGE KNIFE WOOD HANDLE
(Japanese Stainless Steel)

Article No.	Material	Handle	Box Qty.
N60-25	J1	Wood	180



LOOP KNIFE LONG HANDLE WITH BRASS TOPPER
(Japanese Stainless Steel)

Article No.	Material	Handle	Box Qty.
N69-25	J1	Wood	180

TRILLION LOOP KNIFE AND BRUSH WOOD HANDLE
(Japanese Stainless Steel)

Article No.	Material	Handle	Box Qty.
N71-25	J1	Wood	180



LOOP KNIFE LONG THICK HANDLE
(Japanese Stainless Steel)

Article No.	Material	Handle	Box Qty.
N79-25	J1	Wood	180

PROFESSIONAL BIG BIRD KNIFE SHARP EDGE LONG WOOD HANDLE
(Japanese Stainless Steel)

Article No.	Side	Material	Handle	Box Qty.
N09-15	RH	J2	Wood	200
	LH	J2	Wood	200



HOOF KNIVES



TRILLION KNIFE SHARP EDGE HALF DOUBLE LEFT PICK AND BRUSH WOOD HANDLE (Japanese Stainless Steel)

Article No.	Side	Material	Handle	Box Qty.
N73-25	LH	J1	Wood	180

TRILLION KNIFE SHARP EDGE HALF DOUBLE PICK AND BRUSH WOOD HANDLE (Japanese Stainless Steel)

Article No.	Side	Material	Handle	Box Qty.
N72-25	RH	J1	Wood	180



DG KNIFE SHARP EDGE HALF DOUBLE REGULAR WOOD HANDLE (Japanese Stainless Steel)

Article No.	Side	Material	Handle	Box Qty.
N62-25.DB	DB	J1	Wood	288



DG KNIFE SHARP EDGE HALF DOUBLE LEFT REGULAR WOOD HANDLE (Japanese Stainless Steel)

Article No.	Side	Material	Handle	Box Qty.
N74-25	DB	J1	Wood	288



DG KNIFE SHARP EDGE REGULAR WOOD HANDLE (Japanese Stainless Steel)

Article No.	Side	Material	Handle	Box Qty.
N62-25	RH	J1	Wood	288
	LH	J1	Wood	288



TOUGH GUY PICK AND BRUSH WOOD HANDLE (Stainless Steel)

Article No.	Material	Handle	Box Qty.
N52	SS	Wood	200



HOOF KNIFE STRAIGHT FULL DOUBLE EDGE WOOD HANDLE (Japanese Stainless Steel)

Article No.	Side	Material	Handle	Box Qty.
N75-15	FD	J2	Wood	240

We know how to manufacture your ideas

HOOF KNIVES



HORSEMAN KNIFE 5 BLADE FOLDING COLOR HANDLE (Stainless Steel)

Article No.	Material	Handle	Box Qty.
N23-CL	SS	Color Wood	120



HORSEMAN KNIFE 5 BLADE FOLDING (Stainless Steel)

Article No.	Material	Handle	Box Qty.
N23	Brass/SS	Wood	120
N23-57	SS	Wood	120



HORSEMAN KNIFE 6 BLADE FOLDING (Stainless Steel)

Article No.	Material	Handle	Box Qty.
N22-CL	Brass/SS	Colored	120
N22-57	SS	Wood	120



HORSEMAN KNIFE 2 BLADE FOLDING (Stainless Steel)

Article No.	Material	Handle	Box Qty.
N25	SS	Wood	200



HOOF KNIFE HOOK + KNIFE FOLDING (Stainless Steel)

Article No.	Material	Handle	Box Qty.
N24	SS	Aluminum	250



STRIPPING COMB FOLDING KNIFE + COMB (Stainless Steel)

Article No.	Material	Handle	Box Qty.
N49	SS	Wood	200



HOOF KNIFE HOOK + COMB FOLDING (Stainless Steel)

Article No.	Material	Handle	Box Qty.
N47	SS	Aluminum	250

HOOF KNIVES SETS



HOOF KNIFE SET IN POUCH (Stainless Steel)

Article No.	Material	Handle	Set of Blades	Box Qty.
N14-57	SS	Wood	5	75



HOOF KNIFE SET IN POUCH (Stainless Steel)

Article No.	Material	Handle	Set of Blades	Box Qty.
N15-57	SS	Wood	6	75



CARBIDE SHARPENER FOR KNIFE, BLACK COATING (CS/NP)

Article No.	Material	Color	Box Qty.
R31	Carbide	Black	400



PROFESSIONAL HOOF KNIFE SET IN POUCH (Japanese Stainless Steel)

Article No.	Material	Handle	Set of Blades	Box Qty.
N44-15	J2	Black	2	200



SHEATH WITH BELT HANGING (Leather)

Article No.	Material	Color	Box Qty.
N28-BK	Leather	Black	700
N28-BR	Leather	Brown	700



FARRIER APRON 1000-D CORDURA WITH MAGNET (Top Suede Leather)

Article No.	Material	Color	Box Qty.
W76-BK	Cordura	Black	25



FARRIER APRON HEAVY W/POCKETS (Suede Leather)

Article No.	Material	Color	Box Qty.
W176	Leather	Natural	25
		Dark Brown	25



FARRIER APRON HEAVY W/POCKETS (Suede Leather)

Article No.	Material	Color	Box Qty.
W72-BE	Leather	Beige	25
		Brown	25

We know how to manufacture your ideas

FARRIERS KITS



FARRIERS KIT MADE OF CANVAS (Customized Tools Selection Available)

Article No.	Material	Handle	Set of Tools	Box Qty.
R50	Canvas	Black	7	5
R151	Suede	Brown	7	5
R50-BAG		Empty Bag		80



FARRIERS KIT KNIFE BAG MADE OF CANVAS (Customized Tools Selection Available)

Article No.	Material	Handle	Set of Tools	Box Qty.
R150	Synthetic	Brown	6	6



COBRA TOOL BOX RACK (CS/Powder Coated)

Article No.	Material	Color	Box Qty.
R106-BK	62	Black	15
R106-GR	62	Green	15



COBRA LITE TOOL BOX RACK (CS/Powder Coated)

Article No.	Material	Color	Box Qty.
R107	62	BK/GY	15

www.paksmith.com

www.paksmith.com

FOLDING SEAT STICKS

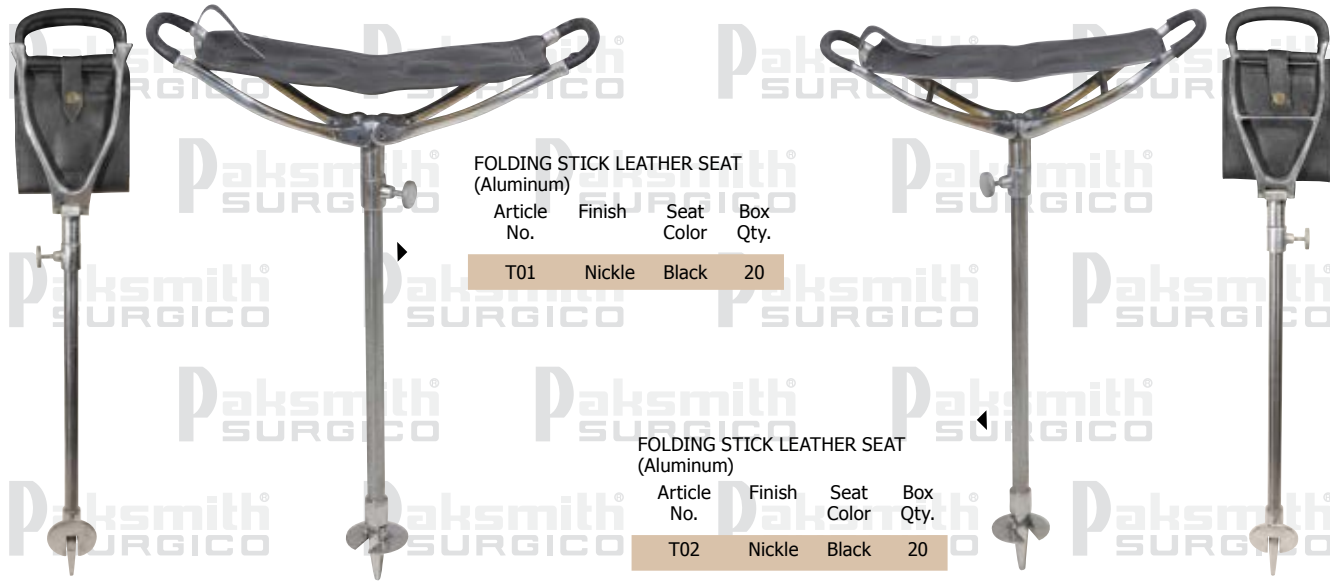

FOLDING STICK LEATHER SEAT
(Aluminum)

Article No.	Finish	Seat Color	Box Qty.
T01	Nickle	Black	20

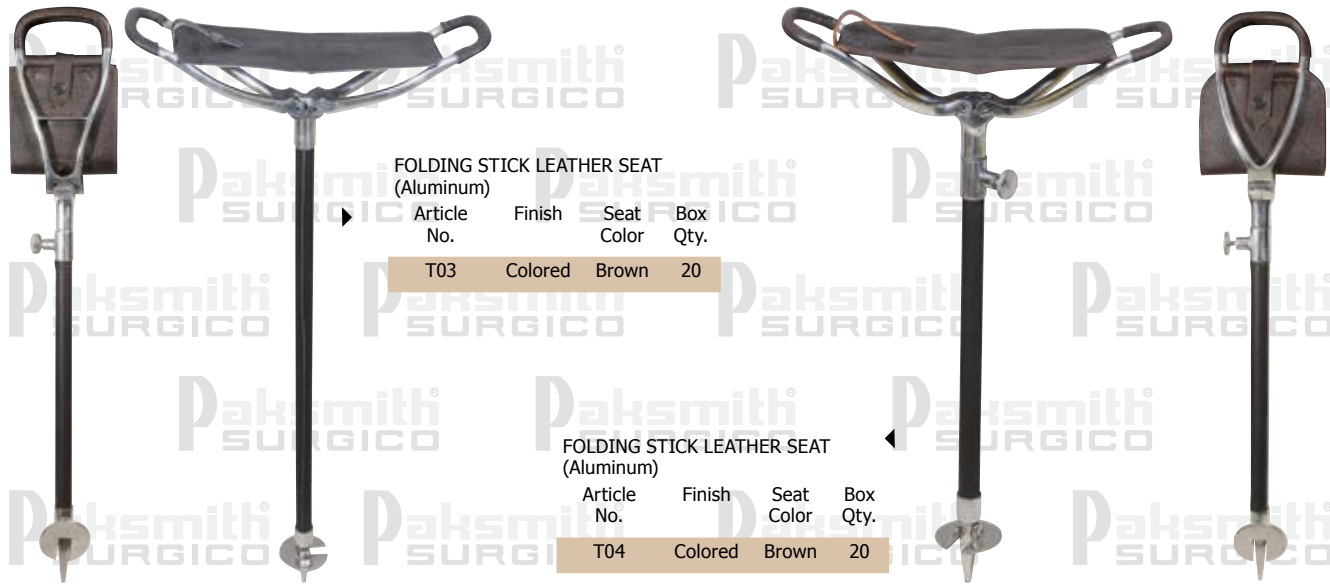

FOLDING STICK LEATHER SEAT
(Aluminum)

Article No.	Finish	Seat Color	Box Qty.
T03	Colored	Brown	20

FOLDING STICK LEATHER SEAT
(Aluminum)

Article No.	Finish	Seat Color	Box Qty.
T04	Colored	Brown	20



FOLDING STICK LEATHER SEAT
(Aluminum)

Article No.	Finish	Seat Color	Box Qty.
T05	Colored	Brown	20

FOLDING STICK LEATHER SEAT
(Aluminum)

Article No.	Finish	Seat Color	Box Qty.
T06	Colored	Black	20



FARRIERS
TOOLS

FARRIER TOOLS



HOOF NIPPER SMALL
(Drop Forged 1045 Steel)

Article No.	Size (mm)	Size (Inch)	Material	Finish	Box Qty.
R75	300	12	07	Satin	40

HOOF NIPPER TAPER ROUND HEAD
(Drop Forged 1045 Steel)

Article No.	Size (mm)	Size (Inch)	Material	Finish	Box Qty.
R76	380	15	07	Satin	24

HOOF NIPPER GE-MODEL
(Drop Forged 1045 Steel)

Article No.	Size (mm)	Size (Inch)	Material	Finish	Box Qty.
R77	380	15	07	Satin	24



HOOF NIPPER TAPER HEAD
(Drop Forged 1045 Steel)

Article No.	Size (mm)	Size (Inch)	Material	Finish	Box Qty.
R73-BK	380	15	07	Colored	24

HOOF NIPPER SMALL
(Drop Forged 1045 Steel)

Article No.	Size (mm)	Size (Inch)	Material	Finish	Box Qty.
R78	350	14	07	Satin	24

HOOF NIPPER HALF MOON ROUND
(Drop Forged 1045 Steel)

Article No.	Size (mm)	Size (Inch)	Material	Finish	Box Qty.
R70	300	12	07	Satin	40
R57	300	12	GE-Pattern		40



HOOF NIPPER TAPER HEAD
(Drop Forged 1045 Steel)

Article No.	Size (mm)	Size (Inch)	Material	Finish	Box Qty.
R73	380	15	07	Satin	24

SHOE PULL OFF DIAMOND MODEL FLAT HEAD
(Drop Forged 1045 Steel)

Article No.	Size (mm)	Size (Inch)	Material	Finish	Box Qty.
R79	330	13	07	Satin	40

SHOE PULL OFF DIAMOND MODEL
(Drop Forged 1045 Steel)

Article No.	Size (mm)	Size (Inch)	Material	Finish	Box Qty.
R56	330	13	07	Satin	40

We know how to manufacture your ideas

FARRIER TOOLS



SMALL PULL OFF
(Drop Forged 1045 Steel)

Article No.	Size (mm)	Size (Inch)	Material	Finish	Box Qty.
R23-BK	300	12	07	Colored	40

HOOF NIPPER STRONG JAWS
(Drop Forged 1045 Steel)

Article No.	Size (mm)	Size (Inch)	Material	Finish	Box Qty.
R71	380	15	07	Satin	24

SMALL PULL OFF
(Drop Forged 1045 Steel)

Article No.	Size (mm)	Size (Inch)	Material	Finish	Box Qty.
R23	300	12	07	Satin	40



HOOF NIPPER DIAMOND MODEL
(Drop Forged 1045 Steel)

Article No.	Size (mm)	Size (Inch)	Material	Finish	Box Qty.
R22	300	12	07	Satin	32
	350	14	07	Satin	24
	380	15	07	Satin	24

HOOF NIPPER STRONG JAWS
(Drop Forged 1045 Steel)

Article No.	Size (mm)	Size (Inch)	Material	Finish	Box Qty.
R74	380	15	07	Satin	24

SHOE PULL OFF
(Drop Forged 1045 Steel)

Article No.	Size (mm)	Size (Inch)	Material	Finish	Box Qty.
R72	390	15-1/2	07	Satin	24



HOOF NIPPER DIAMOND MODEL
(Drop Forged 1045 Steel)

Article No.	Size (mm)	Size (Inch)	Material	Finish	Box Qty.
R22-BK	300	12	07	Colored	32
	380	15	07	Colored	24

HOOF NIPPER STRONG JAWS
(Drop Forged 1045 Steel)

Article No.	Size (mm)	Size (Inch)	Material	Finish	Box Qty.
R74-BK	380	15	07	Colored	24

HOOF NIPPER STRONG JAWS
(Drop Forged 1045 Steel)

Article No.	Size (mm)	Size (Inch)	Material	Finish	Box Qty.
R47	350	14	07	Satin	28

FARRIER TOOLS



HOOF NIPPERS STRONG JAWS
(Drop Forged 1045 Steel)

Article No.	Size (mm)	Size (Inch)	Material	Finish	Box Qty.
R89	380	15	07	Satin	24

HOOF NIPPER SMALL 4cm
(Drop Forged 1045 Steel)

Article No.	Size (mm)	Size (Inch)	Material	Finish	Box Qty.
R88	350	14	07	Satin	28

HOOF NIPPER WIDE-MODEL
(Drop Forged 1045 Steel)

Article No.	Size (mm)	Size (Inch)	Material	Finish	Box Qty.
R138	380	15	07	Satin	24



SHOE PULL OFF DIAMOND MODEL FLAT HEAD
(Drop Forged 1045 Steel)

Article No.	Size (mm)	Size (Inch)	Material	Finish	Box Qty.
R79-BK	330	13	07	Colored	40

HOOF NIPPER OVAL HEAD
(Drop Forged 1045 Steel)

Article No.	Size (mm)	Size (Inch)	Material	Finish	Box Qty.
R87-BK	330	13	07	Colored	28

SHOE PULL OFF DIAMOND MODEL FLAT HEAD
(Drop Forged 1045 Steel)

Article No.	Size (mm)	Size (Inch)	Material	Finish	Box Qty.
R86-BK	330	13	07	Colored	40

WORKING GLOVE
(Split Leather)

Article No.	Size (mm)	Material
Z95	360	Leather



WORKING GLOVE RUBBER CUFF
(Cowhide Leather)

Article No.	Size	Material
Z97	Free	Leather



WORKING GLOVE COTTON CUFF
(Split Leather)

Article No.	Size	Material
Z96	Free	Leather



WORKING GLOVE RUBBER CUFF
(Split Leather)

Article No.	Size	Material
Z98	Free	Leather



SHOE
TOOLS

HOOF TOOLS



HOOF & CLAW NIPPER
(Drop Forged 1045 Steel)

Article No.	Size (mm)	Size (Inch)	Material	Finish	Box Qty.
R46-BK	300	12	07	Colored	28

HOOF & CLAW NIPPER
(Drop Forged 1045 Steel)

Article No.	Size (mm)	Size (Inch)	Material	Finish	Box Qty.
R46	300	12	07	Satin	28

HOOF & CLAW NIPPER
(Drop Forged 1045 Steel)

Article No.	Size (mm)	Size (Inch)	Material	Finish	Box Qty.
R85-BK	300	12	07	Colored	28



SHOE SPREADER STRAIGHT HANDLE
(Drop Forged Stainless Steel)

Article No.	Size (mm)	Size (Inch)	Material	Finish	Box Qty.
R38	350	14	57	Satin	24

SHOE SPREADER ROUNDED HANDLE
(Drop Forged Stainless Steel)

Article No.	Size (mm)	Size (Inch)	Material	Finish	Box Qty.
R91	300	12	57	Satin	24

SHOE SPREADER CURVED HANDLE
(Drop Forged Stainless Steel)

Article No.	Size (mm)	Size (Inch)	Material	Finish	Box Qty.
R98	335	14	57	Satin	24
R98-BK				Black	24



HORSE NAIL CLINCHER GE MODEL
(Drop Forged 1045 Steel)

Article No.	Size (mm)	Size (Inch)	Material	Finish	Box Qty.
R92	350	14	07	Satin	32

SADDLE HORSE CLINCHER
(Drop Forged 1045 Steel)

Article No.	Size (mm)	Size (Inch)	Material	Finish	Box Qty.
R35-BK	330	13	07	Colored	40

SADDLE HORSE CLINCHER
(Drop Forged 1045 Steel)

Article No.	Size (mm)	Size (Inch)	Material	Finish	Box Qty.
R35	330	13	07	Satin	40

R95-BK	330	13	Vinyle Red Handle		40
--------	-----	----	-------------------	--	----

Best products with best prices

HOOF TOOLS



SADDLE HORSE CLINCHER
(Drop Forged 1045 Steel)

Article No.	Size (mm)	Size (Inch)	Material	Finish	Box Qty.
R99-BK	330	13	07	Colored	40

NAIL PULLER DIAMOND PATTERN
(Drop Forged 1045 Steel)

Article No.	Size (mm)	Size (Inch)	Material	Finish	Box Qty.
R36	300	12	07	Satin	50

NAIL PULLER GE PATTERN
(Drop Forged 1045 Steel)

Article No.	Size (mm)	Size (Inch)	Material	Finish	Box Qty.
R49-BK	300	12	07	Satin	40

R36-BK	300	12	07	Colored	50
--------	-----	----	----	---------	----

R49-BK	300	12	07	Colored	40
--------	-----	----	----	---------	----



ADJUSTABLE CLINCHER
(Drop Forged Stainless Steel)

Article No.	Size (mm)	Size (Inch)	Material	Finish	Box Qty.
R90	330	13	57	Satin	30

HOT SHOE TONGS
(Drop Forged 1045 Steel)

Article No.	Size (mm)	Size (Inch)	Material	Finish	Box Qty.
R37	380	15	07	Black	34

HOT FITTING TONGS
(Stainless Steel) Available in Carbon Steel

Article No.	Size (mm)	Size (Inch)	Material	Finish	Box Qty.
R39	360	14	57	Satin	80

R39-BK	360	14	07	Colored	80
--------	-----	----	----	---------	----



FIRE TONGS 15-1/2"
(Drop Forged 1045 Steel)

Article No.	Size (mm)	Size (Inch)	Material	Finish	Box Qty.
R137	6	1/4	07	Polished	34

FIRE TONGS JIM-KEITH 16-1/2"
(Drop Forged 1045 Steel)

Article No.	Size (mm)	Size (Inch)	Material	Finish	Box Qty.
R136	6	1/4	07	Black	30

CLINCH DOUBLE END HIGH TEMPERED
(Drop Forged Steel)

Article No.	Material	Finish	Box Qty.
R197-BK	07	Black	175
R197		Steel	175

R137-BK	8	5/16		Black	34
	10	3/8			
	13	1/2			

	8	5/16			
	10	3/8			
	13	1/2			

HOOF TOOLS



HOOF CLEANER WITH RUBBER GRIP (CS/Nickel Plated)

Article No.	Material	Color	Box Qty.
N51	02	Blue	200

HOOF CLEANER WITH RUBBER GRIP (CS/Nickel Plated)

Article No.	Material	Color	Box Qty.
N45-RD	02	Red	500

HOOF CLEANER BIG WITH RUBBER GRIP (CS/Nickel Plated)

Article No.	Material	Color	Box Qty.
N53-BK	02	Black	400
N53-RD	02	Red	400

HOOF CLEANER HEAVY PLASTIC HANDLE (Stainless Steel)

Article No.	Material	Color	Box Qty.
N54	56	Black	150



HOOF BUFFER HIGH TEMPERED (Drop Forged Steel)

Article No.	Material	Finish	Box Qty.
R07	57	Satin	80
R07-BK	57	Black	80

HOOF BUFFER HIGH TEMPERED (Drop Forged Steel)

Article No.	Material	Finish	Box Qty.
R97	57	Satin	100
R97-BK	57	Black	100

HOOF SCRAPPER HIGH TEMPERED (Stainless Steel)

Article No.	Size (mm)	Size (Inch)	Material	Finish	Box Qty.
R06-BK	300	12	57	Colored	80

HOOF SCRAPPER WITH RUBBER GRIP HIGH TEMPERED (Stainless Steel)

Article No.	Size (mm)	Size (Inch)	Material	Finish	Box Qty.
R06	300	12	57	Satin	80

HOOF SCRAPPER WITH RUBBER GRIP HIGH TEMPERED (Stainless Steel)

Article No.	Size (mm)	Size (Inch)	Material	Colors	Box Qty.
R21	280	11	57	Red	150
	330	13	57	Blue	100
	360	14	57	Black	100

HOOF SCRAPPER WITH STRONG RUBBER GRIP HIGH TEMPERED (Stainless Steel)

Article No.	Size (mm)	Size (Inch)	Material	Colors	Box Qty.
R121	280	11	57	Red	150
	280	11	57	Green	150

Best products with best prices

HOOF TOOLS

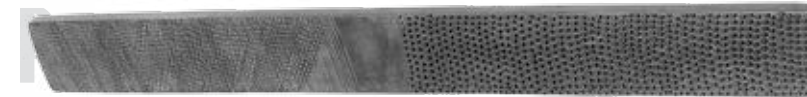

HOOF RASP BOTH SIDE TEETH & FILE (Stainless Steel)

Article No.	Size (mm)	Size (Inch)	Material	Finish	Box Qty.
R05-BK	350	14	57	Colored	40
R05	350	14	57	Satin	40



HOOF RASP BOTH SIDE TEETH (Stainless Steel)

Article No.	Size (mm)	Size (Inch)	Material	Finish	Box Qty.
R04	350	14	57	Satin	30



HOOF RASP ONE SIDE TEETH & OTHER SIDE FILE WITH HANDLE (Stainless Steel)

Article No.	Size (mm)	Size (Inch)	Material	Finish	Box Qty.
R104	350	14	57	Satin	30
R44	Without Handle				30



HOOF RASP S-SHAPE BOTH SIDE RASP (Stainless Steel)

Article No.	Size (mm)	Size (Inch)	Material	Finish	Box Qty.
R43	300	12	57	Satin	100



RASP HANDLE WITH SCREW, BLUE GRIP (Aluminum)

Article No.	Size (mm)	Size (Inch)	Material	Color	Box Qty.
R41	100	4	51	Blue	120



HOOF DIVIDER (Stainless Steel)

Article No.	Material	Box Qty.
R108	57	120

HORSE HOOF GAUGE LEVELER (BRASS)

Article No.	Type	Material	Box Qty.
R28	Horse	33	60
R28-PN	Pony	33	80



DRIVING NAIL HAMMER WOOD HANDLE (Stainless Steel)

Article No.	Size (mm)	Size (Inch)	Material	Handle	Box Qty.
R65	300	12	57	Wood	80



DRIVING NAIL HAMMER WOOD HANDLE (Stainless Steel)

Article No.	Size (mm)	Size (Inch)	Material	Handle	Box Qty.
R55	300	12	57	Wood	80
R55-BK				Colored	80

HOOF TESTERS

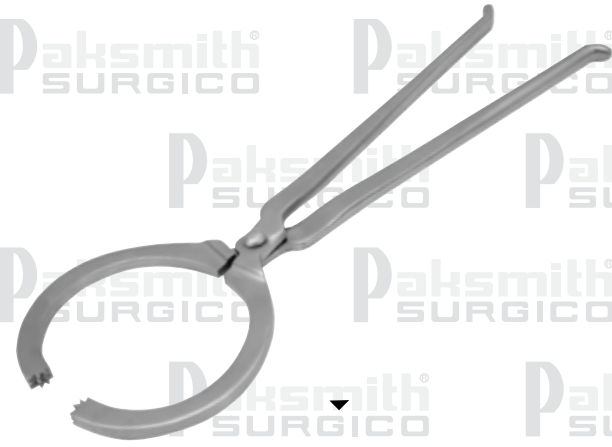

LARGE HOOF TESTER GE MODLE
(Drop Forged Stainless Steel)

Article No.	Size (mm)	Size (Inch)	Material	Finish	Box Qty.
R25	380	15	57	Satin	30
	480	19	57	Satin	20

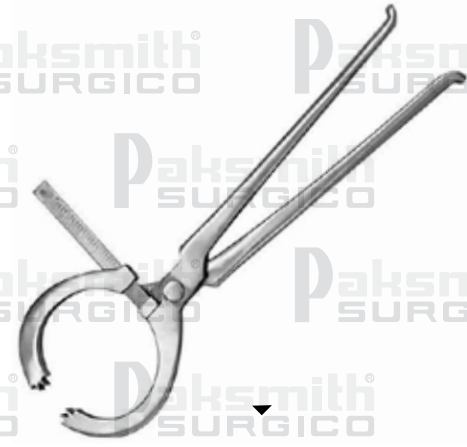

HOOF TESTER ADJUSTABLE
(Drop Forged Stainless Steel)

Article No.	Size (mm)	Size (Inch)	Material	Finish	Box Qty.
R82	380	15	57	Satin	40



LARGE HOOF TESTER ROUND MODEL
(Drop Forged Stainless Steel)

Article No.	Size (mm)	Size (Inch)	Material	Finish	Box Qty.
R80	450	18	57	Satin	20



HOOF TESTER ROUND MODEL
(Drop Forged Stainless Steel)

Article No.	Size (mm)	Size (Inch)	Material	Finish	Box Qty.
R83	380	15	57	Satin	30



HOOF TESTER ROUND MODEL
(Drop Forged Stainless Steel)

Article No.	Size (mm)	Size (Inch)	Material	Finish	Box Qty.
R11	330	13	57	Satin	30
R11-59 Economical Price SS Casted Material					



HOOF TESTER FOR SMALL ANIMALS
(Drop Forged Stainless Steel)

Article No.	Size (mm)	Size (Inch)	Material	Finish	Box Qty.
R51	350	14	57	Satin	40

We know how to manufacture your ideas

HOOF TESTERS



ROUND HOOF TESTER
(Drop Forged Stainless Steel)

Article No.	Size (mm)	Size (Inch)	Material	Finish	Box Qty.
R29	380	15	57	Satin	20



HOOF TESTER ADJUSTABLE
(Drop Forged Stainless Steel)

Article No.	Size (mm)	Size (Inch)	Material	Finish	Box Qty.
R40	380	15	57	Satin	40



HOOF TESTER FLAT MODEL
(Drop Forged Stainless Steel)

Article No.	Size (mm)	Size (Inch)	Material	Finish	Box Qty.
R24	380	15	57	Satin	30



HOOF TESTER FLAT MODEL
(Drop Forged Stainless Steel)

Article No.	Size (mm)	Size (Inch)	Material	Finish	Box Qty.
R12	330	13	57	Satin	40
R12-59 Economical Price SS Casted Material					



LARGE HOOF TESTER FLAT MODEL 5" JAW
(Drop Forged Stainless Steel)

Article No.	Size (mm)	Size (Inch)	Material	Finish	Box Qty.
R84	480	19	57	Satin	20

GROOMING ITEMS



METAL CURRY COMB, THIN TEETH, PLASTIC HANDLE (CS/Powder Coated)

Article No.	Size	Color	Box Qty.
531-1T	7 Rows	Green	80
		Blue	80



METAL CURRY COMB, THICK TEETH, PLASTIC HANDLE (CS/Powder Coated)

Article No.	Size	Color	Box Qty.
531-2T	7 Rows	Green	80
		Blue	80



METAL CURRY COMB WITH MANE, PLASTIC HANDLE (CS/Powder Coated)

Article No.	Size	Color	Box Qty.
532-1T	8 Rows	Blue	80



METAL CURRY COMB, PLASTIC HANDLE (CS/Powder Coated)

Article No.	Size	Color	Box Qty.
532-2T	8 Rows	Blue	80



METAL CURRY COMB WITH MANE, PLASTIC HANDLE (CS/Powder Coated)

Article No.	Size	Color	Box Qty.
532-3T	8 Rows	Red	80



METAL CURRY ROUND COMB, PLASTIC HANDLE (GALVANIZED)

Article No.	Size	Color	Box Qty.
530-06	2 Rows	Green	150

Best products with best prices

GROOMING ITEMS



SCOTCH CURLING COMB, DOUBLE SIDE TEETH (CS/Chrome Plated)

Article No.	Material	Side	Box Qty.
N27-2T	CS/NP	Double	144



SCOTCH CURLING COMB, WHITE WOOD HANDLE (CS/Chrome Plated)

Article No.	Material	Side	Box Qty.
N27-1T	CS/NP	Single	144



HAIR CLIPPER ONE HAND USE (CS/Chrome Plated)

Article No.	Teeth	Type	Box Qty.
560-3T	8	Sheep	100



HAIR CLIPPER WHITE WOOD HANDLE (CS/Chrome Plated)

Article No.	Teeth	Type	Box Qty.
558	33	Horse	52
559	40	Horse	52



HAIR CLIPPER RED WOOD HANDLE (CS/Chrome Plated)

Article No.	Teeth	Type	Box Qty.
557	20	Sheep	52
556	25	Cow	52



HAIR CLIPPER ONE HAND USE (CS/Chrome Plated)

Article No.	Teeth	Type	Box Qty.
560-1T	19	Horse	100

SPARE BLADES AVAILABLE OF ALL CLIPPERS



STRIPPING COMB FOLDING WOOD HANDLE (Stainless Steel)

Article No.	Size (cm)	Color	Box Qty.
N29	8	Wood	250
N29-CL	8	Multi	250
N29-57	8	COMPLETE SS	



COMB ROUGH (Stainless Steel)

Article No.	Size (cm)	Teeth	Box Qty.
N42-3T	24	23	250



ALUMINUM COMB (Aluminum)

Article No.	Teeth	Box Qty.
N42-1T	14	400
N42-2T		400



STRIPPING COMB STRAIGHT (Stainless Steel)

Article No.	Color	Box Qty.
N30-1T	Wood	400
N30-2T	Plastic	400

GROOMING ITEMS



THINNING SCISSOR DOUBLE SIDE TEETH (Stainless Steel)

Article No.	Size (cm)	Material	Box Qty.
P13	18	57	400

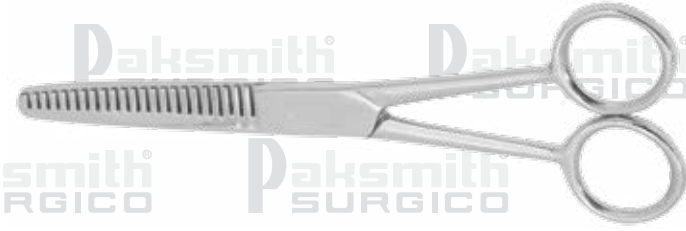

MARKING SCISSOR CRANKED HANDLE (Stainless Steel)

Article No.	Size (cm)	Material	Box Qty.
P12	18	57	400



Cranked upward Handles

MARKING SCISSOR CURVED BLADE (Stainless Steel)

Article No.	Size (cm)	Material	Box Qty.
P11-17	17	57	450
P11-19	19	57	300

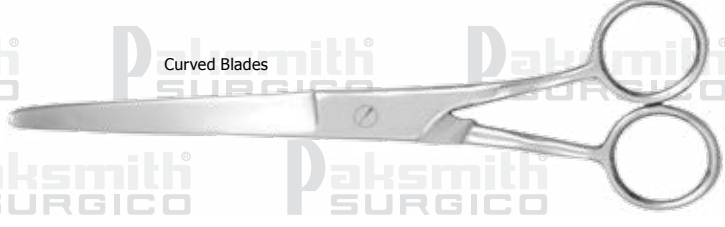

Curved Blades

FETLOCK SCISSOR CURVED BLADE (Stainless Steel)

Article No.	Size (cm)	Material	Box Qty.
P10	20	57	200
P10-G	With Rubber Grip		200
P10-01	CS/Nickel Plated		200



Curved Blades

THINNING SCISSOR DOUBLE SIDE TEETH WITH HOOK (Stainless Steel)

Article No.	Size (cm)	Material	Box Qty.
P08	19	57	400



THINNING SCISSOR ONE SIDE WITH FINGER HOOK (Stainless Steel)

Article No.	Size (cm)	Material	Box Qty.
P07	19	57	350



FETLOCK SCISSOR PLASTIC HANDLE Assorted Colors Available (Stainless Steel)

Article No.	Size (cm)	Color	Type	Box Qty.
P06	20	Black	Straight	250
P17	20	Black	Curved	250



MANE + TAIL TRIM KIT WITH LEATHER CASE (Stainless Steel)

Article No.	Size (cm)	Color	Box Qty.
N26	19	Brown	100



OTHERS
SMETI

OTHER ITEMS



POLO Mallet STICK (STANDARD) W/
RUBBER GRIP

Article No.	Size (Inch)	Material	Box Qty.
W36	51	Bamboo	25
	52	Bamboo	25
	53	Bamboo	25

HORSE MEASURING STICK

Article No.	Size (cm)	Material	Box Qty.
R02-50	180	Bamboo	50
R02-51	180	Aluminum	50



UTILITY SCISSOR PLASTIC HANDLE
(Stainless Steel)

Article No.	Size (cm)	Color	Box Qty.
P05-BK	19	Black	500

Assorted Colors Available



POLO RIDING HELMET
Assorted Colors Available (Standard)

Article No.	Color	Box Qty.
W37-A	Black	12
W37-B	Navy Blue	12
W37-C	Black Velvet	12
W37-D	Blue	12
	Red	12



B



C



D

Best products with best prices

OTHER ITEMS



SHOE HAMMER WOOD HANDLE
WITH RUBBER GRIP (1045 STEEL)

Article No.	Size (mm)	Size (Inch)	Box Qty.
K32	155	6-1/8	40

SHOE HAMMER RED WOOD
HANDLE (1045 STEEL)

Article No.	Size (mm)	Size (Inch)	Box Qty.
K42	155	6-1/8	40

SHOE HAMMER 2-SIDE RED WOOD
HANDLE (1045 STEEL)

Article No.	Size (mm)	Size (Inch)	Box Qty.
K52	100	4	64

SHOE HAMMER RED WOOD
HANDLE (1045 STEEL)

Article No.	Size (mm)	Size (Inch)	Box Qty.
K62	175	6-3/4	64



SHOE HORN METAL
(CARBON STEEL)

Article No.	Size (cm)	Color	Box Qty.
K03-BK	45	Black	96

Assorted Colors Available

SHOE HORN METAL
(CS/CHROME PLATED)

Article No.	Size (cm)	Finish	Box Qty.
K03-02	45	Nickel	144
K03-34	45	Gold	96

Assorted Transparent Colors Available

CS METAL PROTECTOR
Assorted Sizes Available

Article No.	Size	Finish	Box Qty.
K27-0	0	Zinc	6000
K27-1	1	Zinc	3000
K27-2	2	Zinc	3000
K27-3	3	Zinc	2000
K27-4	4	Zinc	2000

SHOE HORN METAL
Assorted Colors Available
(CARBON STEEL)

Article No.	Size (cm)	Finish	Box Qty.
K50-02	19	Nickel	480

Assorted Colors Available

ROUND WASHER

Article No.	Material	Size (mm)
K28-22	Zinc	22
K28-25	Zinc	25

METAL CLIP

Article No.	Material	Box Qty.
K31	Zinc	7500

SHOE HORN METAL (CARBON STEEL)
Assorted Colors Available

Article No.	Size (cm)	Color	Box Qty.
K03-02	12	Chrome	480
K03-GR	14	Green	480
K03-RD	14	Red	480
K03-BL	16	Blue	480
K03-YW	16	Yellow	480

OTHER ITEMS



RIDERS BODY PROTECTOR
(Textile)

Article No.	Color	Size
Y10	Black	All



NATURAL LICKING SALT
WITH ROPE

Article No.	Weight KG	Box Qty.
501	2.5 - 3.0	8
	3.0 - 3.5	8

Available in Brick, Slab Styles

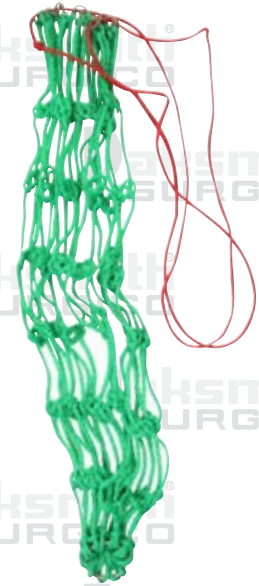

HEY NET 120CM LONG
(Nylon Rope)

Article No.	Color	Size	Box Qty.
K60-10	Green	10x10	200
K60-5	Red	5x5	200

Also available with Steel Rings



HOOKS FOR CURB CHAIN

Article No.	Material
R111-HK.56	SS
R111-HK.33	Brass
R111-HK.87	SW/Iron



HOOKS FOR CURB CHAIN

Article No.	Material
R13-HK.56	SS
R13-HK.33	Brass
R13-HK.87	SW/Iron



S-HOOKS FOR CURB CHAIN

Article No.	Material
R15-HK.56	SS



R14-87



R13-56



R14-56



R14-33

CURB CHAINS WITHOUT HOOKS

Article No.	Material	Links	Box Qty.
R14-87	Sweet Iron	24	300
R13-56	SS	14	350
R13-01	CS/NP	14	350
R14-56	SS	24	300
R14-33	Brass	24	300



SADDLERY
HARDWARE

SADDLERY HARDWARE

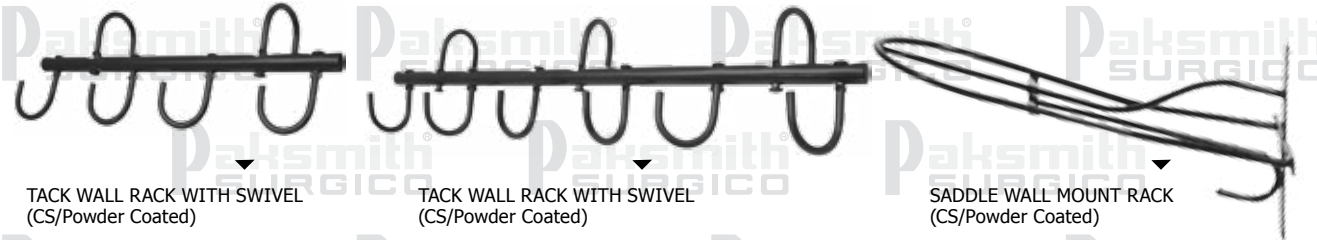

TACK WALL RACK WITH SWIVEL (CS/Powder Coated)

TACK WALL RACK WITH SWIVEL (CS/Powder Coated)

SADDLE WALL MOUNT RACK (CS/Powder Coated)

Article No.	Hooks	Color	Box Qty.
R01-1T	6	Black	40

Article No.	Hooks	Color	Box Qty.
R01-2T	9	Black	30

Article No.	Color	Box Qty.
R105	Black	12
	Red	12
	Green	12



DEE RING (Brass)

Article No.	Material	Size (mm)	Size (Inch)	Box Qty.
R26-33	Brass	40	1-1/2	700
		50	2	700

DEE RING (Stainless Steel)

Article No.	Material	Size (mm)	Size (Inch)	Box Qty.
R26-56	SS	40	1-1/2	700
		50	2	700



ROLLER BUCKEL WITH TONGUES (Stainless Steel)

Article No.	Material	Tongues	Size (mm)	Size (Inch)	Box Qty.
R18-56	SS	Double	50	2	400
R27-56	SS	Single	50	2	600
R27-87	SW/Iron	Single	50	1-1/2	600

BUCKEL WITH TONGUES (Brass) or (Stainless Steel)

Article No.	Material	Tongues	Size (mm)	Size (Inch)	Box Qty.
R08-33	Brass	Single	50	2	400
R08-56	SS	Single	50	2	600



BLEV BUCKLE WITH TONGUE (Stainless Steel)

Article No.	Material	Size (mm)	Size (Inch)	Box Qty.
R16-56	SS	50	2	200

BLEV BUCKLE WITH TONGUE (Stainless Steel)

Article No.	Material	Size (mm)	Size (Inch)	Box Qty.
R62-56	SS	40	2	200

BLEV BUCKLE WITH TONGUE (Stainless Steel)

Article No.	Material	Size (mm)	Size (Inch)	Box Qty.
R63-56	SS	50	2	200

You never got so much for so little

SADDLERY HARDWARE

Exclusively designed

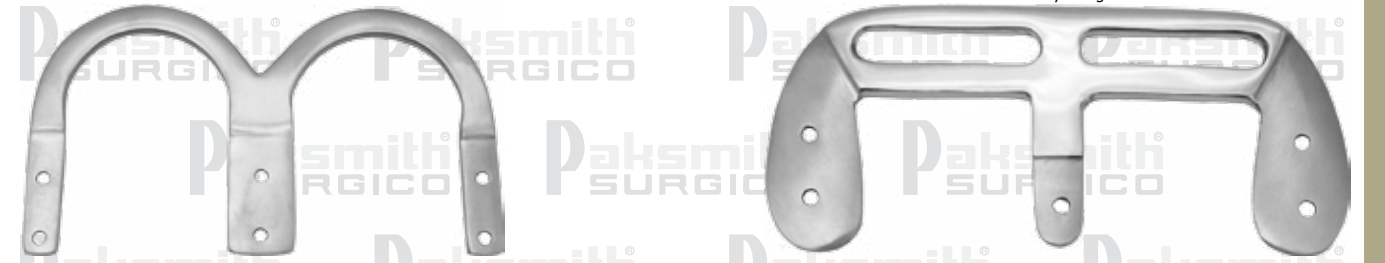

DOUBLE CEE RING (Stainless Steel)

Article No.	Material	Size (mm)	Size (Inch)	Box Qty.
R10-56	SS	Standard		100

BUCKLE FOR SADDLE (Stainless Steel)

Article No.	Material	Size	Box Qty.
R69-56	SS	Standard	100
R69-33	Brass	Standard	100



CEE RING (Stainless Steel)

Article No.	Material	Size (mm)	Size (Inch)	Box Qty.
R09-56	SS	90	3-1/2	250

CEE RING BEVELED (Stainless Steel)

Article No.	Material	Size (mm)	Size (Inch)	Box Qty.
R68-56	SS	90	3-1/2	250

RIGGING PLATE (Brass)

Article No.	Material	Size	Box Qty.
R34-33	Brass	Standard	100



PLATE FOR SADDLE (Stainless Steel)

Article No.	Material	Size (Inch)	Box Qty.
R209-56	SS	2-1/2	200

J-PLATE HEAVY RIGGING (Stainless Steel)

Article No.	Material	Size	Box Qty.
R67-56	SS	Standard	100

BUCKLE FOR SADDLES (Stainless Steel)

Article No.	Material	Size (mm)	Box Qty.
R32-56	SS	40	250
R32-33	Brass	40	250



OVAL DEE RING LITTLE BELV 4-HOLES (Stainless Steel)

Article No.	Material	Size (Inch)	Box Qty.
R58-3	SS	3	100

FLAT DEE RING LITTLE ROUND EDGE (Stainless Steel)

Article No.	Material	Size (mm)	Box Qty.
R177-56	SS	76	100

www.paksmith.com

www.paksmith.com

SADDLERY HARDWARE



PINCHER PLIER WITH STOP AT 50mm OPENING (STAINLESS STEEL)

Article No.	Material	Hole mm	Gap Size mm	Box Qty.
R54	SS	6.80	26	60
R54-1	SS	NO	26	60



MOUNTING PLIER WITH HAMMER (STAINLESS STEEL)

Article No.	Material	Size mm	Box Qty.
R52-20	SS	200	60
R52-24	SS	240	60



PLIER WITHOUT REVOLVING FITTING (STAINLESS STEEL)

Article No.	Material	Size mm	Box Qty.
R53-20	SS		40

ADJUSTABLE HEAD PLATE WITH SIDE BARS (CS/NICKEL PLATED)

Article No.	Material	Size	Box Qty.
R101	CS	Standard	18
R101-S	CS	Small	

SMART SCISSOR ONE SERRATED BLADE PLASTIC HANDLE (Stainless Steel)

Article No.	Size (cm)	Color	Box Qty.
P14-RD	17	Red	600

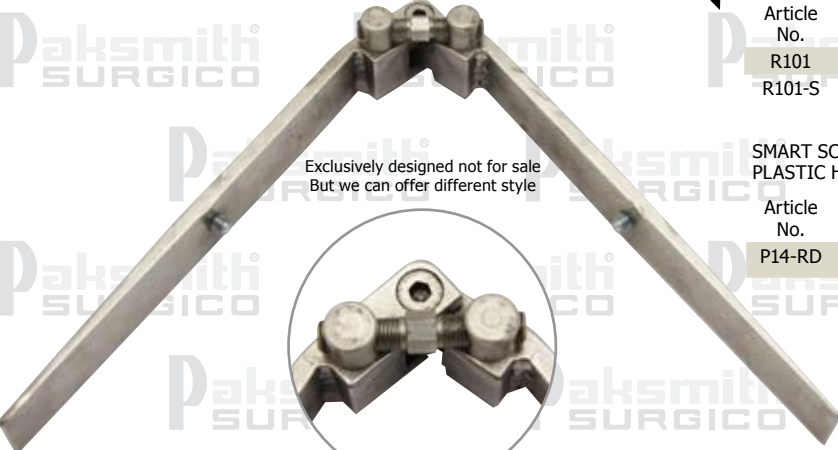

Exclusively designed not for sale But we can offer different style



HALF MOON KNIFE WOOD HANDLE WITH LEATHER COVER (Stainless Steel)

Article No.	Size (mm)	Color	Box Qty.
N43	115	Brown	60

ADJUSTABLE STIRRUP BARS (Stainless Steel)

Article No.	Type	Box Qty.
R109-56	Adjustable	50



STIRRUP BARS STANDARD (CS/Nickel Plated)

Article No.	Type	Box Qty.
R60-02	Without Hole	100
R61-02	With Hole & Thread	100



You never got so much for so little

SADDLERY HARDWARE



DEE RING DEEP BEVELED (Stainless Steel)

Article No.	Material	Size (Inch)	Box Qty.
R20	SS	3-1/2	100



DEE RING LITTLE BEVELED (Stainless Steel)

Article No.	Material	Size (Inch)	Box Qty.
R33-3	SS	3	140
R33.3.1/2	SS	3-1/2	100

DEE RING LITTLE BEVELED WITH 3-HOLES PLATE (Stainless Steel)

Article No.	Material	Size (Inch)	Box Qty.
R93-3.1/2	SS	3-1/2	90



DEE RING DEEP (Stainless Steel)

Article No.	Material	Size (Inch)	Box Qty.
R191-56	SS	2-1/2	300
	SS	3	200
	SS	3-1/2	150



DEE RING (Stainless Steel)

Article No.	Material	Size (Inch)	Box Qty.
R19-56	SS	1-1/2	350
	SS	2	250
	SS	2-1/2	250
	SS	3	250
	SS	3-1/2	120



BREAST COLLAR BUCKLE WITH PLATE (Stainless Steel)

Article No.	Material	Size (Inch)	Box Qty.
R30-1	SS	1	700
R30-1.1/4	SS	1-1/4	500



BREAST COLLAR BUCKLE WITH LONG PLATE (Brass)

Article No.	Material	Size (Inch)	Box Qty.
R131	BRASS	1	700



STRAP BUCKLE LITTLE CURVED (Stainless Steel)

Article No.	Material	Size (Inch)
R100-56	SS	Standard
R100-33	BRASS	



ROLLER BUCKLE FLAT SINGLE TUNG (Sweet Iron) Set of 2

Article No.	Material	Size (cm)	Box Qty.
K24	BLACK	4	125

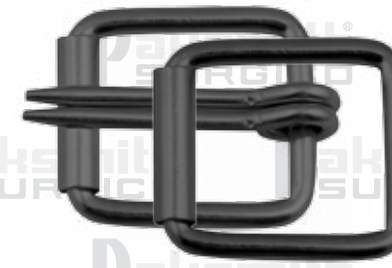

ROLLER BUCKLE FLAT SINGLE TUNG (Sweet Iron) Set of 2

Article No.	Material	Size (cm)	Box Qty.
K25	BLACK	4-1/2	125



Article No.	Material	Size (Inch)	Box Qty.
K26	BLACK	1	750

HORSE DENTAL



TOOTH EXTRACTING FORCEPS (Stainless Steel)

Article No.	Size (cm)	Size (Inch)	Box Qty.
325	48	19	10

TOOTH FORCEPS (Stainless Steel)

Article No.	Size (cm)	Size (Inch)	Box Qty.
322	48	19	10

3-PRONG ROOT MOLAR FORCEPS ONSIDE (Stainless Steel)

Article No.	Size (cm)	Size (Inch)	Box Qty.
319-RH	48	19	10



3-PRONG ROOT MOLAR FORCEPS OFFSIDE (Stainless Steel)

Article No.	Size (cm)	Size (Inch)	Box Qty.
319-LH	48	19	10

TOOTH SPREADER FORCEPS (Stainless Steel)

Article No.	Size (cm)	Size (Inch)	Box Qty.
324	48	19	10

TOOTH FORCEPS HEWSON STYLE (Stainless Steel)

Article No.	Size (cm)	Size (Inch)	Box Qty.
323	37	14-1/2	10



RAINHARD TOOTH FORCEPS (Stainless Steel)

Article No.	Size (cm)	Size (Inch)	Box Qty.
308	43	17	20

TOOTH FORCEPS CURVED HANDLE (Stainless Steel)

Article No.	Size (cm)	Size (Inch)	Box Qty.
305	28	11	40

4-PRONG ROOT MOLAR FORCEPS (Stainless Steel)

Article No.	Size (cm)	Size (Inch)	Box Qty.
326	48	19	10

Continued progress through innovation

HORSE DENTAL



DENTAL FLOAT CURVED REPLACEMENT BLADE (CS/NP)

Article No.	Size (cm)	Size (Inch)	Box Qty.
302-01	56	22	40

TOOTH RASP FIXED HEAD (STAINLESS STEEL)

Article No.	Size (cm)	Size (Inch)	Box Qty.
309-57		28	20

TOOTH RASP STRAIGHT STRONS ALBERT-PATTERN (STAINLESS STEEL)

Article No.	Size (cm)	Size (Inch)	Box Qty.
331			40



TOOTH RASP CURVED STRONS ALBERT-PATTERN (STAINLESS STEEL)

Article No.	Size (cm)	Size (Inch)	Box Qty.
332	53	31	40

Other Sizes Available

UNIVERSAL DENTAL FLOAT HINGED WOOD HANDLE (CS/NP)

Article No.	Size (cm)	Size (Inch)	Box Qty.
311	51	20	50
	66	26	50

UNIVERSAL DENTAL FLOAT (CS/NP)

Article No.	Size (cm)	Size (Inch)	Box Qty.
315-01	51	20	50

HORSE DENTAL



DENTAL FLOAT ADJUSTABLE (CS/NP)

Article No.	Size (cm)	Size (Inch)	Box Qty.
310-01	51	20	50
	66	26	50



UNIVERSAL DENTAL FLOAT CHANGEABLE BLADE SET OF 3 (CS/NP)

Article No.	Size (cm)	Size (Inch)	Box Qty.
314-01			50



REPLACEMENT BLADE FOR DENTAL FLOAT (CS)

Article No.	Size (cm)	Size (Inch)	Box Qty.
310-BLD			



DENTAL MIRROR 50MM DIA 25° ANGLE

Article No.	Size (cm)	Size (Inch)	Box Qty.
333	48	19	100



SCHOUBE 2-1/3" DISTANCE (STAINLESS STEEL)

Article No.	Size (cm)	Size (Inch)	Box Qty.
638-57	6	2-1/3	50



BAYER MOUTH WEDGE FOR HORSE & CATTLE (STAINLESS STEEL)

Article No.	Size (cm)	Size (Inch)	Box Qty.
636	Standard		30

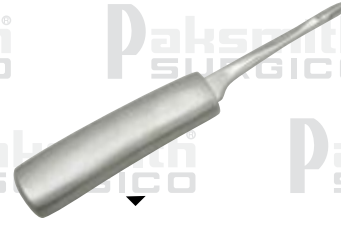

DENTAL ELEVATOR ALUMINUM HANDLE (STAINLESS STEEL)

Article No.	Size (cm)	Size (Inch)	Box Qty.
612-57	Standard		200



HOLBORN MOUTH GAG FOR HORSE WITH STRONG LEATHER STRAP (DROP FORGED SS)

Article No.	Size	Strap Color	Strap Type	Box Qty.
639-55	Horse	Brown	Leather	10
639-BK			Nylon	10

GLOVES MEASUREMENT CHART

Glove Chart	Inches	cm
Adult XS	7"-7.5"	17.5-19
Adult S	7.5"-8"	19-20
Adult M	8"-9"	20-23
Adult L	9"-9.5"	23-24
Adult XL	9.5"-10"	24-25.5
Adult XXL	10"-11"	25.5-28

Measure Around the hand at the fullest point excluding thumb
Use chart to determine size.



RIDING GLOVES

GLOVES



RIDING GLOVE, U-STYLE COWHIDE LEATHER

Article No.	Size	Color	Material
Z100	M	Yellow	Mesh Cloth



RIDING GLOVE, PALM COWHIDE LEATHER, VELCRO STRAP

Article No.	Size	Color	Material
Z101	M	Yellow	Mesh Cloth



RIDING GLOVE, PALM SUEDE LEATHER, VELCRO STRAP

Article No.	Size	Color	Material
Z102	M	Green	4 Way Cloth



RIDING GLOVE, SHUKSHAL FABRIC WITH VELCRO STRAP

Article No.	Size	Color	Material
Z103	M	Green	Knob Gripe



RIDING GLOVE, PALM SYNTHETIC LEATHER, ELASTIC GRIP

Article No.	Size	Color	Material
Z104-BL	M	Blue	4 Way Cloth



RIDING GLOVE, PALM SYNTHETIC LEATHER, ELASTIC GRIP

Article No.	Size	Color	Material
Z104-RD	M	Red	4 Way Cloth



RIDING GLOVE, SYNTHETIC LEATHER WITH VELCRO STRAP

Article No.	Size	Color	Material
Z106	M	Brown	Synthetic



RIDING GLOVE, FULL MESH CLOTH VELCRO STRAP

Article No.	Size	Color	Material
Z107	M	Yellow	Mesh Cloth



RIDING GLOVE, PALM COWHIDE LEATHER, VELCRO STRAP

Article No.	Size	Color	Material
Z108	M	Black	4 Way Dot

Best products with best prices

GLOVES



RIDING GLOVE, COWHIDE ALA-LINE WITH VELCRO STRAP

Article No.	Size	Color	Material
Z109	M	Beige	Cowhide



RIDING GLOVE, FULL DIGITAL SUEDE VELCRO STRAP

Article No.	Size	Color	Material
Z110	M	Black	Synthetic



RIDING GLOVE WIND STOPPER WATERPROOF PALM SYNTHETIC

Article No.	Size	Color	Material
Z111	M	Black	Synthetic



RIDING GLOVE, NUBICK SUEDE LYCRA WITH VELCRO STRAP

Article No.	Size	Color	Material
Z112	M	Black	Nuibuck



RIDING GLOVE, WIND STOPPER KNOB PALM VELCRO STRAP

Article No.	Size	Color	Material
Z113	M	Black	Synthetic



RIDING GLOVE, SERENO VELCRO STRAP

Article No.	Size	Color	Material
Z114	M	Black	Synthetic



RIDING GLOVE, FULL COWHIDE LEATHER 40gm THINSULATE

Article No.	Size	Color	Material
Z115-BR	M	Brown	Cowhide



RIDING GLOVE, FULL COWHIDE LEATHER 40gm THINSULATE

Article No.	Size	Color	Material
Z115-BK	M	Black	Cowhide



RIDING GLOVE, FULL AIR SERENO SUMMER, VELCRO STRAP

Article No.	Size	Color	Material
Z117	M	Black	Sereno

GLOVES



RIDING GLOVE, SYNTHETIC LEATHER DOUBLE PROTECTION, VELCRO STRAP

Article No.	Size	Color	Material
Z118	M	Black	Synthetic



RIDING GLOVE, FULL COWHIDE WITH LECRA, VELCRO STRAP

Article No.	Size	Color	Material
Z119	M	Brown	Cowhide



RIDING GLOVE, FULL MESH GOAT SKIN STRAP, VELCRO STRAP

Article No.	Size	Color	Material
Z11	M	Beige	Mesh Cloth



KIDS RIDING GLOVE SUEDE PALM BACK 4-WAY VELCRO STRAP

Article No.	Size	Color	Material
Z120	06	Beige	Synthetic



KIDS RIDING GLOVE SUEDE PALM BACK 4-WAY VELCRO STRAP

Article No.	Size	Color	Material
Z120-PK	06	Pink	Synthetic



KIDS RIDING GLOVE SUEDE PALM BACK 4-WAY VELCRO STRAP

Article No.	Size	Color	Material
Z121-GR	06	Green	Synthetic



KIDS RIDING GLOVE SUEDE PALM BACK 4-WAY VELCRO STRAP

Article No.	Size	Color	Material
Z121-HP	06	Hot Pink	Synthetic



KIDS RIDING GLOVE SUEDE PALM BACK 4-WAY VELCRO STRAP

Article No.	Size	Color	Material
Z120-LM	06	Lemon	Synthetic



TEAM ROPER GLOVE SYNTHETIC PALM BACK 4-WAY CLOTH VELCRO STRAP

Article No.	Size	Color	Material
Z50	M	Blue	Synthetic
Z52	L	Red	Kevlar Palm

Best products with best prices

GLOVES



RIDING GLOVE, COWHIDE LEATHER VELCRO STRAP

Article No.	Size	Color	Material
Z69	M	Brown	Cowhide



RIDING GLOVE, COWHIDE LEATHER ELASTIC GRIP VELCRO STRAP

Article No.	Size	Color	Material
Z70	M	Brown	Cowhide



RIDING GLOVE, COWHIDE LEATHER ELASTIC GRIP

Article No.	Size	Color	Material
Z71-BR	M	Brown	Cowhide
Z71-BK	L	Black	Cowhide



RIDING GLOVE, COWHIDE LEATHER WITH SUEDE LEATHER VELCRO STRAP

Article No.	Size	Color	Material
Z72	M	Brown	Cowhide



RIDING GLOVE, COWHIDE ALA-LINE ELASTIC GRIP VELCRO STRAP

Article No.	Size	Color	Material
Z74	M	Yellow	Cowhide



RIDING GLOVE, COWHIDE ALA-LINE WITH ADJUSTABLE ROPE

Article No.	Size	Color	Material
Z75-YW	M	Yellow	Cowhide
Z75-BK	L	Black	Cowhide



RIDING GLOVE, COWHIDE LEATHER VELCRO STRAP

Article No.	Size	Color	Material
Z76	M	Brown	Cowhide

Also available in Ladies Sizes



RIDING GLOVE, COWHIDE ALA-LINE ELASTIC GRIP VELCRO STRAP

Article No.	Size	Color	Material
Z77	M	Beige	Cowhide



RIDING GLOVE, COWHIDE PALM WITH MESH FABRIC VELCRO STRAP

Article No.	Size	Color	Material
Z78	M	Brown	Cowhide

GLOVES



DRIVING GLOVE FULL COWHIDE LEATHER

Article No.	Size	Color	Material
Z64	M	Brown	Cowhide



RIDING GLOVE COWHIDE WITH HOLES ELASTIC GRIP

Article No.	Size	Color	Material
Z67	M	Brown	Cowhide



RIDING GLOVE SHEEP SKIN INSIDE FINGER MESH VELCRO STRAP

Article No.	Size	Color	Material
Z60-BR	M	Brown	Sheep



RIDING GLOVE PALM COWHIDE, FRONT BEIGE MESH CLOTH

Article No.	Size	Color	Material
Z79-CB	M	Brown	Cowhide
Z79-CM	L	Camel	Cowhide



COTTON RIDING GLOVE LADIES WITH COWHIDE LEATHER VELCRO STRAP

Article No.	Size	Color	Material
Z51	M	Brown	Mesh Cloth
Z73	L	Leather Between Fingers	



RIDING GLOVE PALM COWHIDE FRONT SUEDE LEATHER VELCRO STRAP

Article No.	Size	Color	Material
Z56	M	Brown	Cowhide



DRIVING GLOVE FULL COWHIDE LEATHER VELCRO STRAP

Article No.	Size	Color	Material
Z57	M	Brown	Cowhide



RIDING GLOVE PALM COWHIDE FRONT MESH CLOTH VELCRO STRAP

Article No.	Size	Color	Material
Z58	M	Brown	Cowhide



RIDING GLOVE ECONOMIC GOOD GRIP ELASTIC CUFF

Article No.	Size	Color	Material
Z53-BK	6	Black	Artificial
Z53-BR	6-1/2	Brown	Artificial

MEASURING INSTRUCTIONS

1. Height Measurement From Back Of The Knee Up To Ankle.

2. Calf Measurement Measure The Widest Part Of Your Calf.

Note:
 1. Galters Are 4-6cm High From Outer Side Of Leg From The Knee Part
 2. High Shaped Half Chaps Are Also 2-4cm High From The Knee Part
 3. These additional measurements are not included In Length Measurements.

SIZE CHART

	Size	Height	Calf
Adult	XS	37cm	29-31
	S	38cm	30-32
	M	40cm	32-34
	L	41cm	34-36
	XL	42cm	36-38
Children	XXL	42cm	39-41
	XXXS	cm	27-29
	XXS	cm	28-30
	6	cm	24-27
	8	cm	27-29
	10	cm	29-32
	12	cm	32-35

Measurements Are in cm Sizes Are Approximate
 Special Sizing Can Manufacture On Customer Demand



CHAPS

CHAPS



LEATHER GAITER HALF CHAP,
(Assorted Colors & Sizes Available)

Article No.	Color	Size	Box Qty.
W152	Black	M	50

LEATHER GAITER HALF CHAP,
(Assorted Colors & Sizes Available)

Article No.	Color	Size	Box Qty.
W152	Brown	M	50

You never got so much for so little

CHAPS



COWHIDE LEATHER HALF CHAP,
(Assorted Colors & Sizes Available)

Article No.	Color	Size	Box Qty.
W156	Black	M	50

COWHIDE LEATHER HALF CHAP,
(Assorted Colors & Sizes Available)

Article No.	Color	Size	Box Qty.
W157	Brown	M	50



COWHIDE LEATHER HALF CHAP
(Assorted Colors & Sizes Available)

Article No.	Color	Size	Box Qty.
W154	Brown	M	50

LEATHER HALF CHAP, INSIDE ELASTIC
(Assorted Colors & Sizes Available)

Article No.	Color	Size	Box Qty.
W155	Black	M	50



SYNTHETIC LEATHER HALF CHAP,
(Assorted Colors & Sizes Available)

Article No.	Color	Size	Box Qty.
W153	Black	M	50

COWHIDE SOFT LEATHER HALF CHAP,
(Assorted Colors & Sizes Available)

Article No.	Color	Size	Box Qty.
W158	Brown	M	50

CHAPS



COWHIDE LEATHER HALF CHAP,
(Assorted Colors & Sizes Available)

Article No.	Color	Size	Box Qty.
W159	Brown	M	50

MINI SUEDE LEATHER HALF CHAP,
(Assorted Colors & Sizes Available)

Article No.	Color	Size	Box Qty.
W73	Brown	M	50

You never got so much for so little

CHAPS



COWHIDE SOFT LEATHER HALF CHAP,
(Assorted Colors & Sizes Available)

Article No.	Color	Size	Box Qty.
W165	Black	M	50

COWHIDE SOFT LEATHER HALF CHAP,
(Assorted Colors & Sizes Available)

Article No.	Color	Size	Box Qty.
W164	Black	M	50

www.paksmith.com



COWHIDE SOFT LEATHER HALF CHAP,
(Assorted Colors & Sizes Available)

Article No.	Color	Size	Box Qty.
W161	Black	M	50

COWHIDE LEATHER GAITER CHAP,
(Assorted Colors & Sizes Available)

Article No.	Color	Size	Box Qty.
W162	Black	M	50



AMARA LEATHER HALF CHAP,
(Assorted Colors & Sizes Available)

Article No.	Color	Size	Box Qty.
W168	Brown	M	50

AMARA LEATHER HALF CHAP,
(Assorted Colors & Sizes Available)

Article No.	Color	Size	Box Qty.
W169	Brown	M	50

www.paksmith.com

CHAPS



SYNTHETIC LEATHER HALF CHAP, GREY STRIP & STRAP
(Assorted Colors & Sizes Available)

Article No.	Color	Size	Box Qty.
W167-GY	Black	M	50

SYNTHETIC LEATHER HALF CHAP, ORANGE STRIP & STRAP
(Assorted Colors & Sizes Available)

Article No.	Color	Size	Box Qty.
W167-OR	Black	M	50

You never got so much for so little

CHAPS



SYNTHETIC LEATHER HALF CHAP, GREEN STRIP & STRAP
(Assorted Colors & Sizes Available)

Article No.	Color	Size	Box Qty.
W167-GR	Black	M	50

NEOPRENE HALF CHAP, BLACK AMARA DESIGN WITH STRAP
(Assorted Colors & Sizes Available)

Article No.	Color	Size	Box Qty.
W118	Blue	M	50

www.paksmith.com



SYNTHETIC LEATHER HALF CHAP, RED STRIP & STRAP
(Assorted Colors & Sizes Available)

Article No.	Color	Size	Box Qty.
W167-RD	Black	M	50

SYNTHETIC LEATHER HALF CHAP, SKY BLUE STRIP & STRAP
(Assorted Colors & Sizes Available)

Article No.	Color	Size	Box Qty.
W167-SB	Black	M	50



SYNTHETIC LEATHER HALF CHAP,
(Assorted Colors & Sizes Available)

Article No.	Color	Size	Box Qty.
W170	Purple	M	50

SYNTHETIC LEATHER HALF CHAP,
(Assorted Colors & Sizes Available)

Article No.	Color	Size	Box Qty.
W171	Brown	M	50

www.paksmith.com

CHAPS



SYNTHETIC LEATHER HALF CHAP,
GREY STRIPS
(Assorted Colors & Sizes Available)

Article No.	Color	Size	Box Qty.
W172-GY	Black	M	50

SYNTHETIC LEATHER HALF CHAP,
SKY BLUE STRIPS
(Assorted Colors & Sizes Available)

Article No.	Color	Size	Box Qty.
W172-SB	Black	M	50

You never got so much for so little

CHAPS



NEOPRENE HALF CHAP, BLACK AMARA
(Assorted Colors & Sizes Available)

Article No.	Color	Size	Box Qty.
W173-OR	Orange	M	50

NEOPRENE HALF CHAP, BLACK AMARA
(Assorted Colors & Sizes Available)

Article No.	Color	Size	Box Qty.
W173-GY	Grey	M	50

www.paksmith.com



SYNTHETIC LEATHER HALF CHAP,
ORANGE STRIPS
(Assorted Colors & Sizes Available)

Article No.	Color	Size	Box Qty.
W172-OR	Black	M	50

SYNTHETIC LEATHER HALF CHAP,
BLUE STRIPS
(Assorted Colors & Sizes Available)

Article No.	Color	Size	Box Qty.
W172-BL	Black	M	50



NEOPRENE HALF CHAP, BLACK AMARA
(Assorted Colors & Sizes Available)

Article No.	Color	Size	Box Qty.
W173-WH	White	M	50

NEOPRENE HALF CHAP, BLACK AMARA
(Assorted Colors & Sizes Available)

Article No.	Color	Size	Box Qty.
W173-SB	Sky Blue	M	50

www.paksmith.com

CHAPS



SYNTHETIC LEATHER HALF CHAP,
ROUND SHAPE
(Assorted Colors & Sizes Available)

Article No.	Color	Size	Box Qty.
W101	Black	M	50

SYNTHETIC LEATHER HALF CHAP,
D-STRAP
(Assorted Colors & Sizes Available)

Article No.	Color	Size	Box Qty.
W102	Brown	M	50

You never got so much for so little

CHAPS



SYNTHETIC LEATHER HALF CHAP,
(Assorted Colors & Sizes Available)

Article No.	Color	Size	Box Qty.
W105	Black	M	50

COWHIDE MILD LEATHER HALF CHAP,
(Assorted Colors & Sizes Available)

Article No.	Color	Size	Box Qty.
W106	Brown	M	50

www.paksmith.com



SYNTHETIC LEATHER HALF CHAP,
WITH AMARA PROTECTION
(Assorted Colors & Sizes Available)

Article No.	Color	Size	Box Qty.
W103	Brown	M	50

ARTIFICIAL LEATHER HALF CHAP,
INSIDE ELASTIC
(Assorted Colors & Sizes Available)

Article No.	Color	Size	Box Qty.
W104	Black	M	50



COWHIDE SOFT LEATHER HALF CHAP,
(Assorted Colors & Sizes Available)

Article No.	Color	Size	Box Qty.
W107	Brown	M	50

SYNTHETIC LEATHER SPECIAL CHAP,
(Assorted Colors & Sizes Available)

Article No.	Color	Size	Box Qty.
W108	Black	M	50

www.paksmith.com

CHAPS



COWHIDE PLAIN LEATHER HALF CHAP,
(Assorted Colors & Sizes Available)

Article No.	Color	Material	Box Qty.
W109	Brown	M	50



SYNTHETIC LEATHER HALF CHAP, WITH
PINK PIPING HIDDEN ZIPPER
(Assorted Colors & Sizes Available)

Article No.	Color	Size	Box Qty.
W110	Black	M	50

You never got so much for so little

CHAPS



SYNTHETIC LEATHER HALF CHAP,
BEIGE PIPING HIDDEN ZIPPER
(Assorted Colors & Sizes Available)

Article No.	Color	Size	Box Qty.
W113	Black	M	50



SYNTHETIC LEATHER HALF CHAP, WITH
SUMMER NET HIDDEN ZIPPER (Assorted
Colors & Sizes Available)

Article No.	Color	Size	Box Qty.
W114	Brown	M	50

www.paksmith.com



SYNTHETIC LEATHER HALF CHAP,
BLACK PIPING HIDDEN ZIPPER
(Assorted Colors & Sizes Available)

Article No.	Color	Material	Box Qty.
W111	Black	M	50



SYNTHETIC LEATHER HALF CHAP,
HIDDEN ZIPPER
(Assorted Colors & Sizes Available)

Article No.	Color	Material	Box Qty.
W112	Black	M	50



SYNTHETIC LEATHER HALF CHAP,
HIDDEN ZIPPER
(Assorted Colors & Sizes Available)

Article No.	Color	Size	Box Qty.
W115	Black	M	50



SYNTHETIC LEATHER HALF CHAP,
CENTER D-PLASTIC
(Assorted Colors & Sizes Available)

Article No.	Color	Size	Box Qty.
W116	Black	M	50

www.paksmith.com

CHAPS



COWHIDE LEATHER CHAP,
(Assorted Colors & Sizes Available)

Article No.	Color	Size	Box Qty.
W185	BR/BL	M	50

Article No.	Color	Size	Box Qty.
W122	Black	M	50

You never got so much for so little

CHAPS



COWHIDE LEATHER CHAP,
(Assorted Colors & Sizes Available)

Article No.	Color	Size	Box Qty.
W123	Black	M	50

SYNTHETIC LADIES NARROW CHAP,
(Assorted Colors & Sizes Available)

Article No.	Color	Size	Box Qty.
W124	Black	M	50

www.paksmith.com



COWHIDE LEATHER CHAP,
(Assorted Colors & Sizes Available)

Article No.	Color	Size	Box Qty.
W183	Brown	M	50

Article No.	Color	Size	Box Qty.
W150	Brown	M	50



NEOPRENE HALF CHAP,
(Assorted Colors & Sizes Available)

Article No.	Color	Size	Box Qty.
W45	Black	M	50

SYNTHETIC HALF CHAP,
(Assorted Colors & Sizes Available)

Article No.	Color	Size	Box Qty.
W125-PK	Pink	M	50

www.paksmith.com

CHAPS



SYNTHETIC HALF CHAP,
(Assorted Colors & Sizes Available)

Article No.	Color	Size	Box Qty.
W125-BL	Purple	M	50



SUMMER NET HALF CHAP,
WITH BLUE STRIPS
(Assorted Colors & Sizes Available)

Article No.	Color	Size	Box Qty.
W126	Black	M	50

You never got so much for so little

CHAPS



NEOPRENE HALF CHAP,
(Assorted Colors & Sizes Available)

Article No.	Color	Size	Box Qty.
W145	RD/BK	M	50



AMARA HALF CHAP,
(Assorted Colors & Sizes Available)

Article No.	Color	Size	Box Qty.
W63	Black	M	60

www.paksmith.com



SYNTHETIC LADIES NARROW CHAP,
(Assorted Colors & Sizes Available)

Article No.	Color	Size	Box Qty.
W124-BR	Brown	M	50



SYNTHETIC HALF CHAP,
(Assorted Colors & Sizes Available)

Article No.	Color	Size	Box Qty.
W125-WH	White	M	50



SYNTHETIC HALF CHAP,
(Assorted Colors & Sizes Available)

Article No.	Color	Size	Box Qty.
W128	Brown	M	50



SYNTHETIC HALF CHAP, SUMMER
WITH PINK STRIPS
(Assorted Colors & Sizes Available)

Article No.	Color	Size	Box Qty.
W66-PK	Pink	M	50

www.paksmith.com

CHAPS



SYNTHETIC HALF CHAP,
(Assorted Colors & Sizes Available)

Article No.	Color	Size	Box Qty.
W129	BL/BK	M	50



SUMMER NET HALF CHAP,
WITH BROWN STRIPS
(Assorted Colors & Sizes Available)

Article No.	Color	Size	Box Qty.
W130	BE/BR	M	50

You never got so much for so little

CHAPS



COWHIDE LEATHER GAITER CHAP
(Assorted Colors & Sizes Available)

Article No.	Color	Size	Box Qty.
W133	Black	M	50



COWHIDE LEATHER GAITER CHAP
(Assorted Colors & Sizes Available)

Article No.	Color	Size	Box Qty.
W134	Black	M	50

www.paksmith.com



SYNTHETIC HALF CHAP,
WITH SUMMER NET
(Assorted Colors & Sizes Available)

Article No.	Color	Size	Box Qty.
W131	BR/BK	M	50



COWHIDE LEATHER HALF CHAP
(Assorted Colors & Sizes Available)

Article No.	Color	Size	Box Qty.
W132	Black	M	50



COWHIDE LEATHER GAITER CHAP
(Assorted Colors & Sizes Available)

Article No.	Color	Size	Box Qty.
W135	Black	M	50



SYNTHETIC HALF CHAP,
(Assorted Colors & Sizes Available)

Article No.	Color	Size	Box Qty.
W136	Brown	M	50

www.paksmith.com

CHAPS



Article No.	Color	Size	Box Qty.
W142	Black	M	50

Article No.	Color	Size	Box Qty.
W137	BL/BK	M	50

You never got so much for so little

CHAPS



Article No.	Color	Size	Box Qty.
W140	Black	M	50

Article No.	Color	Size	Box Qty.
W23	Black	M	50

www.paksmith.com



Article No.	Color	Size	Box Qty.
W138	Black	M	50

Article No.	Color	Size	Box Qty.
W139	Black	M	50



Article No.	Color	Size	Box Qty.
W166	BK/BR	M	50

Article No.	Color	Size	Box Qty.
W141	Black	M	50

www.paksmith.com

CHAPS



Article No.	Color	Size	Box Qty.
W151	Black	M	50

Article No.	Color	Size	Box Qty.
W147	Black	M	50

You never got so much for so little

CHAPS



Article No.	Color	Size	Box Qty.
W174	Black	M	50

Article No.	Color	Size	Box Qty.
W175	Black	M	50



Article No.	Color	Size	Box Qty.
W143	BK/GY	M	50

Article No.	Color	Size	Box Qty.
W145	BK/RD	M	50



Article No.	Color	Size	Box Qty.
W177	Black	M	50

Article No.	Color	Size	Box Qty.
W178	BK/CR	M	50

CHAPS

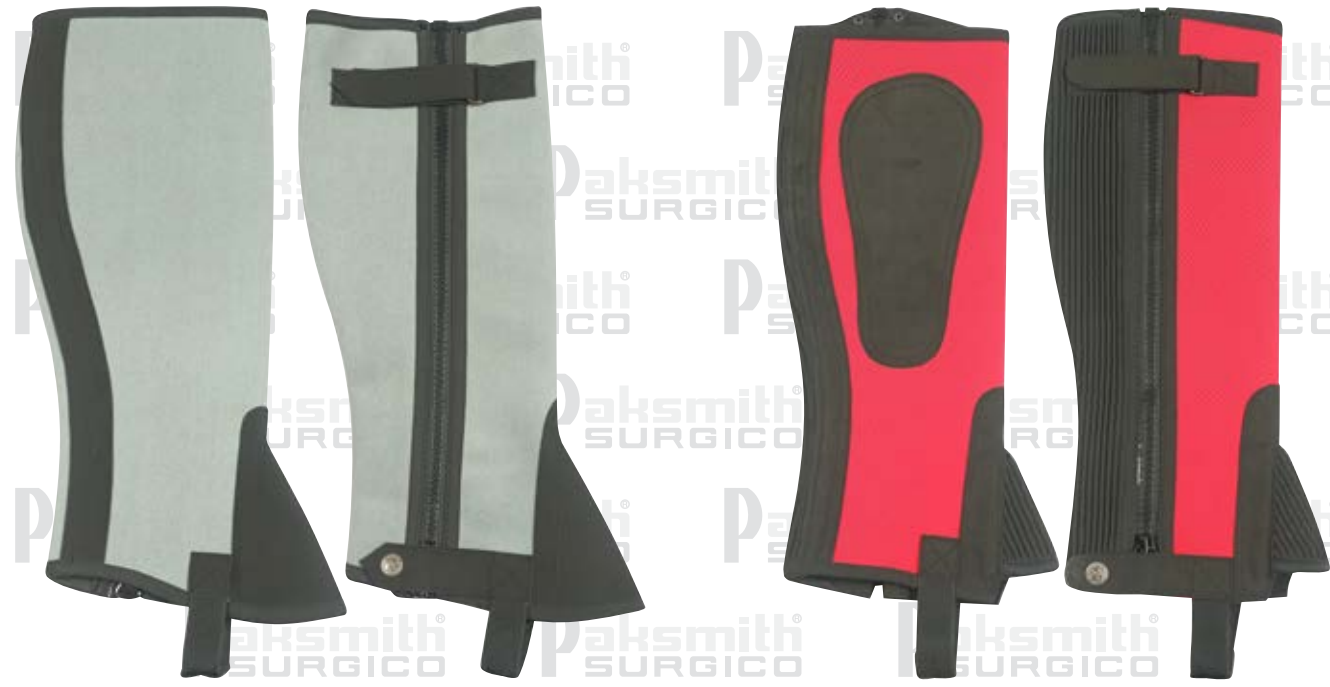

Article No.	Color	Size	Box Qty.
W180	BK/GY	M	50

Article No.	Color	Size	Box Qty.
W179	BK/RD	M	50

You never got so much for so little

CHAPS



Article No.	Color	Size	Box Qty.
W184	BK BK / BR	M	50

Article No.	Color	Size	Box Qty.
W117	Black	M	50

www.paksmith.com



Article No.	Color	Size	Box Qty.
W181	BK/BL	M	50

Article No.	Color	Size	Box Qty.
W182	Black	M	50



Article No.	Color	Size	Box Qty.
W121	BK / BR Black	M	50

Article No.	Color	Size	Box Qty.
W186	Black	M	50

www.paksmith.com

CHAPS



BLACKWOOD CHINKS HEAVY
(Cowhide Leather)

Article No.	Size	Color	Material	Box Qty.
W15	M	Black	Cowhide	25
	L	Brown	Suede	25



SCHOOLING LONG CHAP
All sizes available (Suede Leather)

Article No.	Size	Color	Material	Box Qty.
W20	L	Black	Suede	30



SHOT GUN LONG CHAP
All sizes available (Suede Leather)

Article No.	Size	Color	Material	Box Qty.
W21	L	Black	Suede	30

You never got so much for so little

HORSE BOOTS / BANDAGE ROLL



HORSE FRONT TENDON BOOTS,
DOUBLE VELCRO STRAPS

Article No.	Color	Size	Box Qty.
W16	White	M	50
	Black	L	50

MEDICIN HORSE BOOT, VELCRO CLOSURE

Article No.	Color	Size	Box Qty.
W318	Aqua Blue	M	50

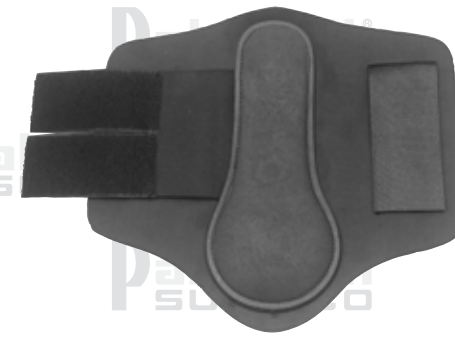

SPLINT HORSE BOOT FRONT LEGS,
VELCRO CLOSURE

Article No.	Color	Size	Box Qty.
W18	White	M	50
	Black	L	50



ANKLE FETLOCK BOOTS,
VELCRO CLOSURE

Article No.	Color	Size	Box Qty.
W17	White	M	50
	Black	L	50



HORSE BOOTS, VELCRO STRAPS

Article No.	Color	Size	Box Qty.
W214	Blue	M	50
	Black	L	50
	Red	50	



HORSE BANDAGE ROLL
(All Colors Available)

Article No.	Color	Box Qty.
W215	Beige	50
	Black	50
	Pink	50
	Red	50

SADDLE PADS



COTTON SADDLE PAD (Textile)
 Article No. Color Size
 W327 Red Full



COTTON SADDLE PAD (Textile)
 Article No. Color Size
 W328 Red Full



COTTON SADDLE PAD (Textile)
 Article No. Color Size
 W329 Red Full
 Blue Full



COTTON SADDLE PAD (Textile)
 Article No. Color Size
 W27 Blue Full



COTTON SADDLE PAD (Textile)
 Article No. Color Size
 W330 Red Full



COTTON SADDLE PAD (Textile)
 Article No. Color Size
 W26 Green Full



COTTON SADDLE PAD (Textile)
 Article No. Color Size
 W128-CB Choco Brown Pony
 W129-CB With Fur Full
 W130-CB Pocket / Fur Full



SADDLE TRANSPORT COVER
 Article No. Color Size Box Qty.
 W227-WH White Standard 100



SADDLE COVER INSIDE FLEECE
 Article No. Color Size Box Qty.
 W225-BK Black Standard 60

You never got so much for so little

PROMOTIONAL ITEMS



COTTON SADDLE PAD (Textile)
 Article No. Color Size
 W328 Red Full



COTTON SADDLE PAD (Textile)
 Article No. Color Size
 W328 Red Full



COTTON SADDLE PAD (Textile)
 Article No. Color Size
 W328 Red Full



COTTON SADDLE PAD (Textile)
 Article No. Color Size
 W328 Red Full



COTTON SADDLE PAD (Textile)
 Article No. Color Size
 W328 Red Full



COTTON SADDLE PAD (Textile)
 Article No. Color Size
 W328 Red Full



COTTON SADDLE PAD (Textile)
 Article No. Color Size
 W328 Red Full

QUALITIES OR MATERIAL

BLS	Black Leather Straps	01	Steel Nickel Plated
C	Child / Youth	02	Steel Chrome Plated
CV	Curved	03	Hollow Mouth
CL	Multi Color Wood	04	Brass Plated
D	Brass Decoration	05	Carbon Steel Polished
E	Hand Engrave Art	06	Steel Galvanized / Zinc
G	Rubber Grip	07	1045-Steel (High Tempered)
PL	Plain Blade	13	Copper
SR	Serrated Blade	14	Cast Iron
PN	Pony	15	J2 Japanese Steel
NS	Nylon Strap	25	J1 Japanese Steel
KS	Kids Small	28	Brass with Black Color
XS	Extra Small	29	Copper with Stainless Steel Rings / Cheeks
S	Small	30	Stainless with Black Color
M	Medium / Men	33	Solid Brass
L	Large / Ladies	34	Steel Transparent Color
XL	Extra Large	35	Brass Chrome Plated
XXL	X-Extra Large	36	Brass with Stainless Steel Rings / Cheeks
BE	Beige Color	37	1095-Steel
BG	Burgundy Color	38	Blue Iron w/Stainless Steel Rings / Cheeks
BK	Black Color	39	Stainless Steel with Sweet Iron Cheeks
BL	Blue Color	40	German Silver Highly Polished
BR	Brown Color	43	German Silver
CB	Choco Brown Color	44	Wood
CM	Camel Color	46	Anodized Color
GL	Gold Color	47	Paper Coating
GR	Green Color	48	Aluminum Colored
LM	Lemon Green Color	49	Aluminum Sheet Alloy
NY	Navy Color	50	Bamboo
OR	Orange Color	51	Aluminum
PK	Pink Color	52	Aluminum Powder Coated
PR	Purple Color	55	Stainless Steel High Grade
RD	Red Color	56	Stainless Steel
RB	Red Brown Color	57	Stainless Steel Magnetic
RT	Rust Color	58	Stainless Steel Magnetic with Plastic
SL	Sliver Color	59	Stainless Steel Magnetic Casted
SB	Sky Blue Color	61	Stainless Steel High Polished
YW	Yellow Color	62	Steel Powder Coated
WH	White Color	63	Aluminum Transparent Color
GY	Grey Color	71	Black Rubber
ST	Straight	72	White Rubber
FD	Full Double Edge	76	Blue Rubber
DB	Half Double Edge	77	Red Rubber
RH	Right Hand	78	Stainless Steel Mouth with German Silver Nut
LH	Left Hand	86	Sweet Iron with Copper Lines / Roller
		87	Sweet Iron / Mail able Iron
		88	German Silver w/Stainless Steel Rings / Cheeks
		89	Aurigan with Aurigan Rings / Cheeks

Measures		Measures	
mm	inch	cm	inch
1,0 mm	3/64	60,0 mm	2.23/64
1,5 mm	1/16	65,0 mm	2.9/16
2,0 mm	5/64	70,0 mm	2.3/4
2,5 mm	3/32	75,0 mm	2.61/64
3,0 mm	1/8	80,0 mm	3.5/32
4,0 mm	5/32	90,0 mm	3.35/64
5,0 mm	13/64	95,0 mm	3.47/64
6,0 mm	15/64		
7,0 mm	9/32		
8,0 mm	5/16		
9,0 mm	23/64		
10,0 mm	25/64		
11,0 mm	7/16		
12,0 mm	15/32		
13,0 mm	33/64		
14,0 mm	35/64		
15,0 mm	5/8		
16,0 mm	5/8		
17,0 mm	43/64		
18,0 mm	45/64		
19,0 mm	3/4		
20,0 mm	3/4		
21,0 mm	53/64		
22,0 mm	55/64		
23,0 mm	29/32		
24,0 mm	15/16		
25,0 mm	1		
27,0 mm	1.1/16		
28,0 mm	1.7/64		
30,0 mm	1.1/4		
32,0 mm	1.17/64		
33,0 mm	1.19/64		
35,0 mm	1.3/8		
36,0 mm	1.27/64		
38,0 mm	1.1/2		
40,0 mm	1.5/8		
45,0 mm	1.3/4		
50,0 mm	1.31/32		
55,0 mm	2.5/32		

cm	inch
10,0 cm	4
10,5 cm	4.1/8
11,0 cm	4.1/4
11,5 cm	4.1/2
12,0 cm	4.3/4
12,0 cm	5
13,0 cm	5.1/8
13,5 cm	5.1/4
14,0 cm	5.1/2
14,5 cm	5.3/4
15,0 cm	6
15,5 cm	6.1/8
16,0 cm	6.1/4
16,0 cm	6.1/2
17,0 cm	6.3/4

Types	
1T	Type1
2T	Type2
3T	Type3
4T	Type4
5T	Type5

Art. No. + Qualities or Material + Size
A01 - 56 . 120







Paksmith[®] SURGICO

WE KNOW HOW TO MANUFACTURE

68, 70-C GHALIB ROAD,
INDUSTRIAL ESTATE-1,
SIALKOT - 51310, PAKISTAN

Phone: +92 (0) 52 / 355 0 118
Fax: +92 (0) 52 / 355 74 55

WhatsApp:  +92 (0) 333 / 555 0 118
Email: info@paksmith.com
Skype: paksmithgroup
Facebook:  paksmithgroup



All rights reserved. Technical alterations are possible this catalogue may be used for no other purposes than offering, buying and selling of our products.

No Part may be copied or reproduced in any form.
In the case of misuse we retain rights o recall our catalogs and price lists to take legal actions.

© 2018 PAKSMITH. ALL RIGHTS RESERVED